



ORAC

BY OUTWATER

Unexpected Possibilities

Samples



We understand the need for product samples. As such, samples are available for many of the products within this catalog; to test their suitability for your intended use or application. Most samples are shipped free of charge via standard U.S. mail or UPS ground. Other shipping options are available, at customer's expense. Please call us (1-800-631-8375) to discuss with our sales representatives.

TERMS AND CONDITIONS

"Vendor": Outwater Industries, Inc.

PRICES:

All prices are subject to change without notice. No deduction will be allowed at settlement. Minimum order is \$25.00 (Merchandise only). Orders less than this minimum will be billed as \$25.00 plus shipping charges and tax, if applicable.

NOTE:

Orders are accepted with the understanding that they will be billed at the price in effect on the day of shipment.

PICK UP ORDERS:

Orders placed for pick up must be picked up within 2 weeks from the date placed, or the date material becomes available. Orders not picked up within 2 weeks will be canceled.

To secure material for a longer time period; arrangements may be made for non-refundable prepayment and pick up by a specified date.

SHIPPING TERMS:

Shipments are F.O.B. shipping point.



3 LOCATIONS

(800) 631-8375

EAST COAST SHOWROOM
24 River Road • Bogota, NJ 07603

EAST COAST WAREHOUSE
390 N. Pennsylvania Ave. • Wilkes Barre, PA 18702

WEST COAST
4720 West Van Buren St. • Phoenix, AZ 85043

*** WE RESERVE THE RIGHT TO SUBSTITUTE OR "EQUAL" ***

OUTDOOR APPLICATIONS

All Purotouch® products can be used outside. Always use DecoFix Power as installation glue and DecoFix Ultra for the joints. Please ensure all Purotouch® products are finished with an exterior paint. Please make sure that any products being fitted externally are installed when the temperature is 41 degrees Fahrenheit or above.

CERTIFICATES AVAILABLE

ISO 45001 Certificate | ISO 14001 Certificate | Acoustic Absorption Certificate 3D Wall Covering

Our Sustainable Future

At Orac, we've always believed that there are many sides to a wall, and we are committed to choosing the good one. In a world where design often feels transient, we've chosen a different path.

Sustainability goes beyond the use of recycled materials; it's about designing ideas that stand the test of time. We understand that true sustainability means creating products that remain relevant for generations, not just a few fleeting years.

Our vision is to become restorative by 2050. This ambitious goal drives our material choices and operational practices, ensuring that every step we take not only minimizes environmental harm but actively contributes to ecological restoration. Since 2018 we have been making profound changes in the full life-cycle of our products. From selection and use of raw materials all the way to our production process.



BIOCIRCULAR MATERIALS

Orac's designs merge recycled and bio-based materials, emphasizing sustainable innovation.



SUSTAINABLE OPERATIONS

Orac has been CO₂ neutral since 2021, working towards climate positivity by 2050.



BUILT TO LAST, BUILT RESPONSIBLY

Our durable products with a lasting lifetime support a sustainable, circular economy.

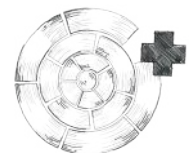

MORE THAN WALLS

Orac's commitment to sustainability extends to community engagement and social responsibility.

Materials

As a pioneer, Orac has introduced synthetic technology for the production of their decorative elements. Synthetic materials have more advantages than traditional plaster, wood or MDF solutions.

Orac's synthetic materials are not only lightweight, easy to handle, sturdy and durable but also completely recyclable.

Boasting product quality that is second-to-none, Orac's decorative mouldings and ornaments are primed and ready for painting/finishing.



PUROTOUCH®

A high-quality, medium-density polyurethane that allows fine details.

Detail Design ☆☆☆

Impact Resistance ☆☆☆

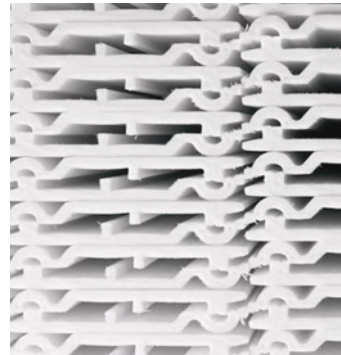

DUROPOLYMER®

An extruded and impact-resistant polymer based on a high-density polystyrene.

Detail Design ☆☆☆

Impact Resistance ☆☆☆



DUROFOAM®

An extruded lightweight polymer based on a low-density polystyrene blend.

Detail Design ☆☆☆

Impact Resistance ☆☆☆



FLEX

A quality high-density flexible polyurethane.

Detail Design ☆☆☆

Impact Resistance ☆☆☆

Steel Molds

the benefits of

Orac has become a leader in the industry through innovation and creative design. Part of what makes Orac so unique is the use of steel molds to produce the high level of defined, rich detail that Orac is known for. The use of steel molds also enhances all of Orac's exclusive materials, formulated specifically to create long lasting, beautiful products.

This process provides crisp, sharp details and unlike rubber molds, steel molds do not warp or degrade during production ensuring that each and every Orac moulding is identical.



Build Up

Orac's standard mouldings collection features large, one-piece profiles that provide an effortless installation. These mouldings feature one-piece construction, and eliminate the need for build-up and the possibility of post construction separation or cracks. Orac's mouldings are incredibly lightweight, easy to work with, and can be installed with everyday woodworking tools. The large profiles are more cost effective than traditional build-ups, saving time and labor during installation and will enhance any pre-existing architecture with ease.

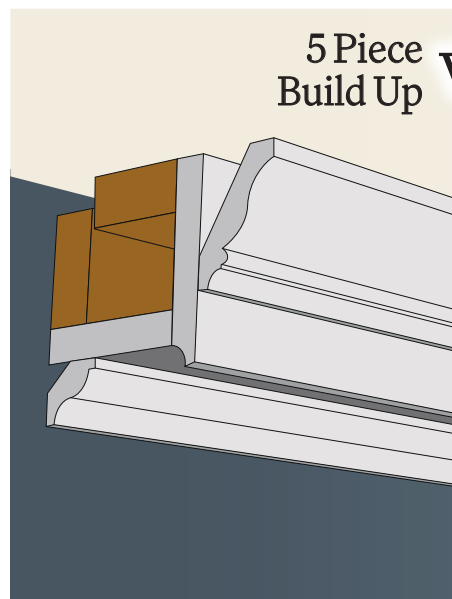

Our Designers

Ulf Moritz
Xavier Donck

Orio Tonini
Pierre Daems

Jacques Vergracht



Orac has teamed up with many of the industry's top European designers and architects to develop new and innovative profiles. Working with these designers allows Orac to stay up to date on the latest design trends and create truly inspired profiles that fit an array of different styles.

Collaborating with these world-renowned designers and architects has resulted in a collection of unique profiles and 3D wall decor that the industry has never seen before. Orac's collection of profiles and high-quality 3D ornaments breaks away from traditional style mouldings and features a "less is more" theme employed by designers and architects like Ulf Moritz, Xavier Donck, Orio Tonini, Pierre Daems and Jaques Vergracht.

Incorporating their ideas into the clean-cut lines and styles of this collection has enabled Orac to open up a whole new era of architectural mouldings and designs that will continue to grow.

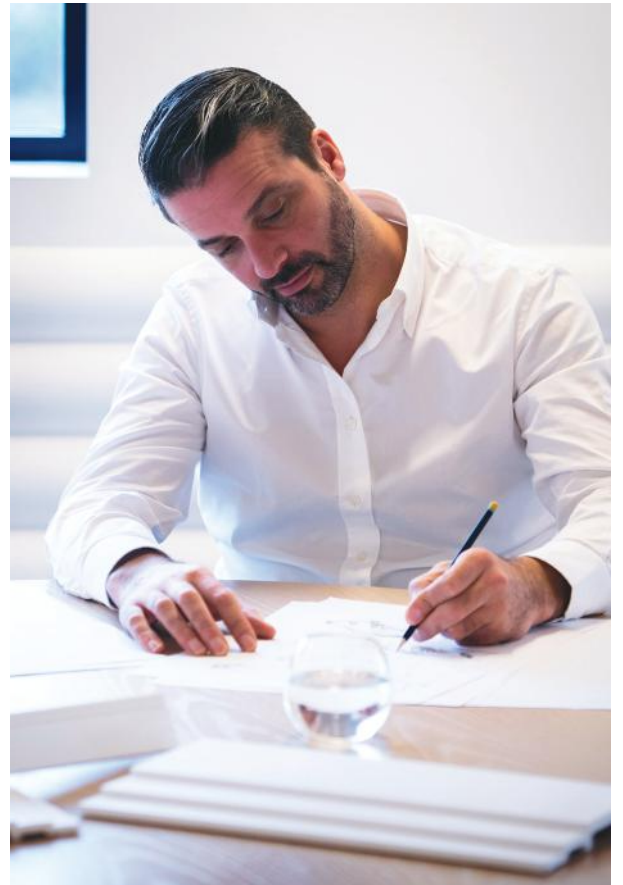

Technical

Orac strives to produce the highest quality products for its customers and provides any information needed for a smooth installation. Technical drawings can be downloaded by visiting www.oracdecorusa.com, where you can also find videos that show various methods of installation for the complete Orac line of products.

Available In

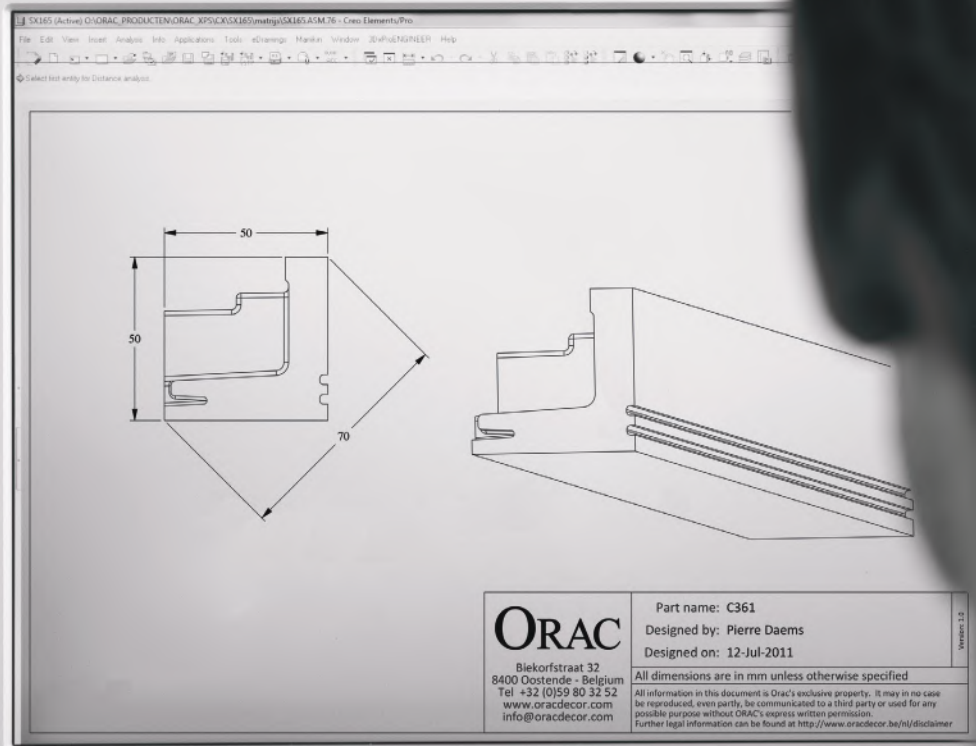

Orac is a unique company with numerous patents, showcasing its innovative approach to architectural decorations and design.

GIVE WALLS
PERSONALITY





- 

1 PX103 pg. 60
- 

2 W122 pg. 85
- 

3 C339 pg. 46
- 

4 W113 pg. 74
- 

5 P8030 pg. 61
- 

6 SX195 pg. 69



1 SX194

pg. 68

2 W112

pg. 74

3 SX157

pg. 68

4 SX171

pg. 69





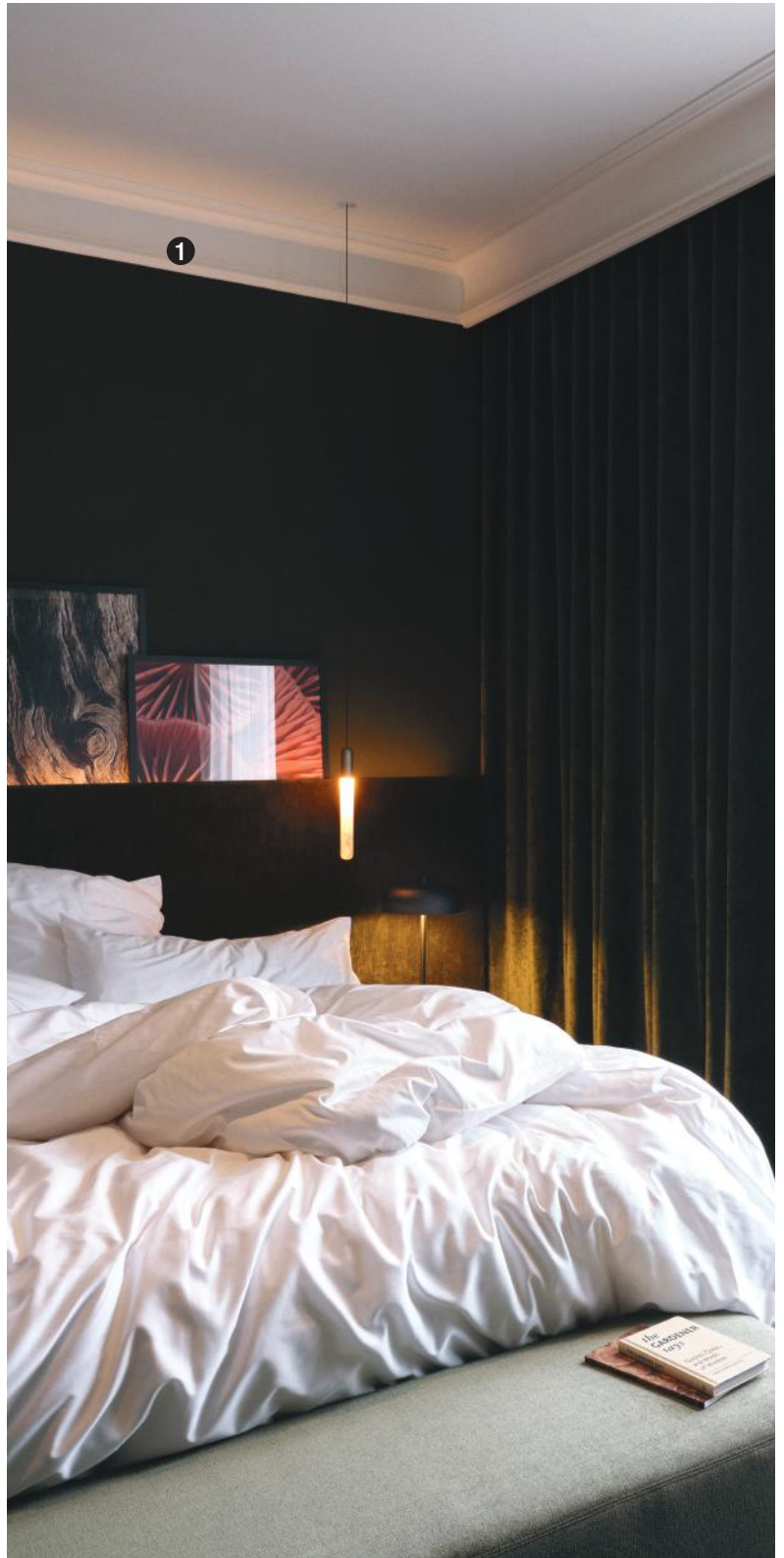

1 C342 pg. 49



2 DX170-2300 pg. 89



3 D330LR pg. 89



4 SX155 pg. 70



5 C343 pg. 52







❶ W109 | W109F pg. 74

❷ W110 | W110F pg. 74

❸ CX190F pg. 35







1 C332 pg. 50



2 W214 pg. 75



3 W215 pg. 75



4 SX138 pg. 70

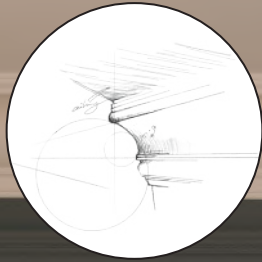

1

2

3

4



1 C343

pg. 52



2 P8020

pg. 62



3 P4020

pg. 61



4 SX206

pg. 71



1

x

2

3

4



1 W109

pg. 74



2 P9010

pg. 63



3 P9050

pg. 60



4 SX155

pg. 70

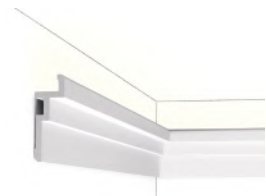

1 CX196

pg. 36

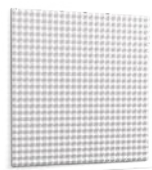

2 W117

pg. 75

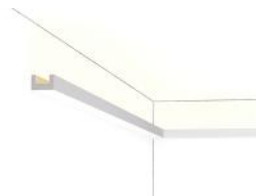

3 CX190

pg. 35



4 PX198

pg. 63



1 C343 pg. 52



2 P8020 pg. 62

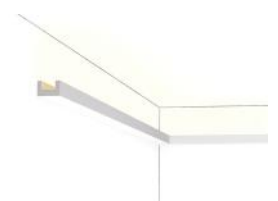

3 CX190 pg. 35



4 W109 pg. 74



5 P4020 pg. 61



6 SX191 pg. 71



7 DX170-2300 pg. 89



8 D330LR pg. 89



1 W212

pg. 75



2 C323

pg. 42



3 W109

pg. 74



4 PX209

pg. 60



5 SX118

pg. 70

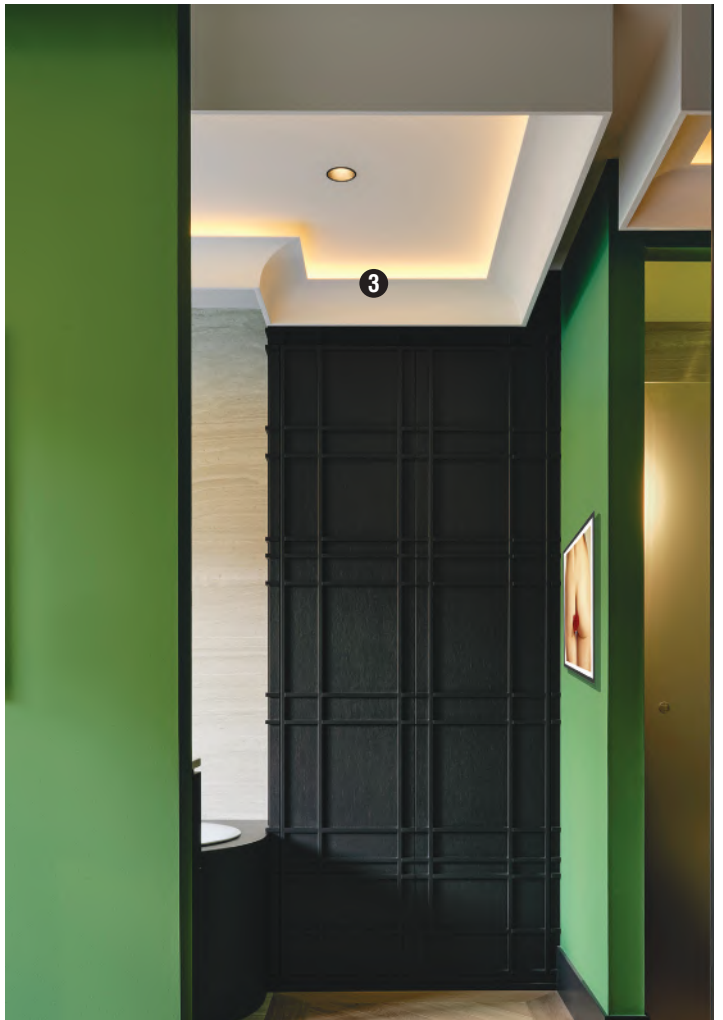

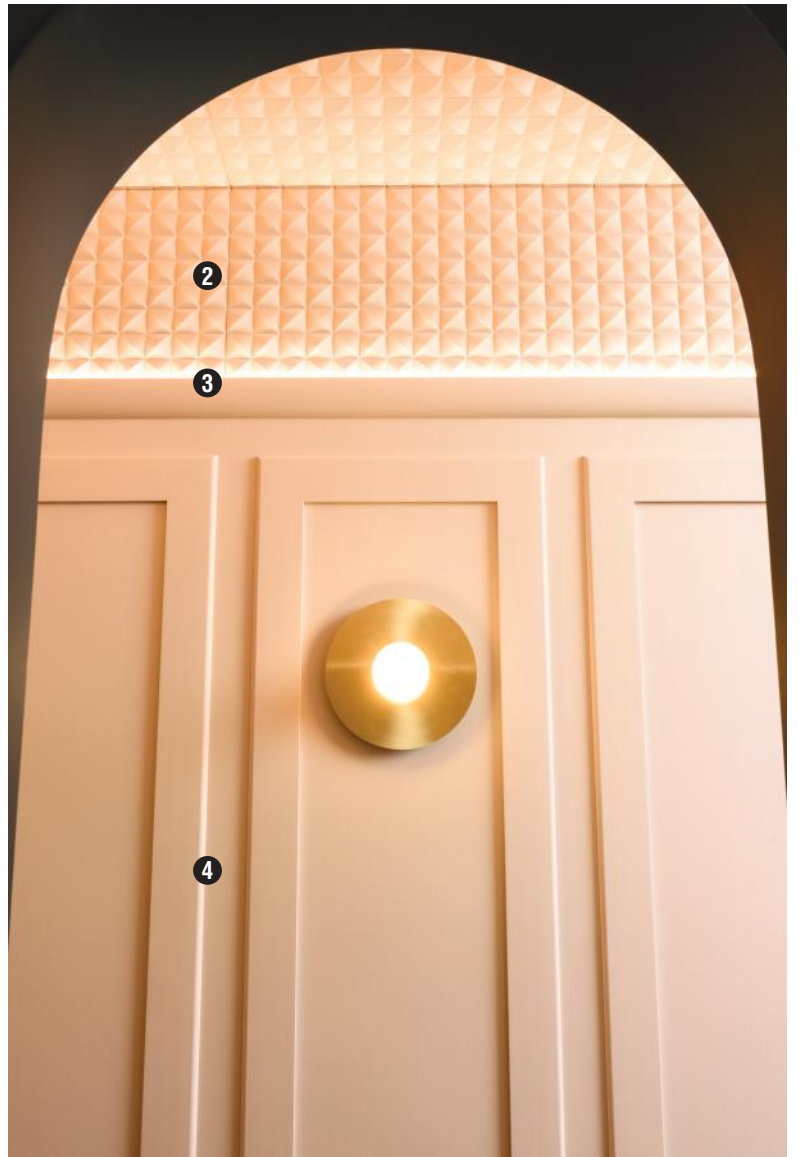



1 CX127 pg. 45



4 PX116 pg. 60



2 PX120 pg. 60



5 SX137 pg. 69



3 PX103 pg. 60

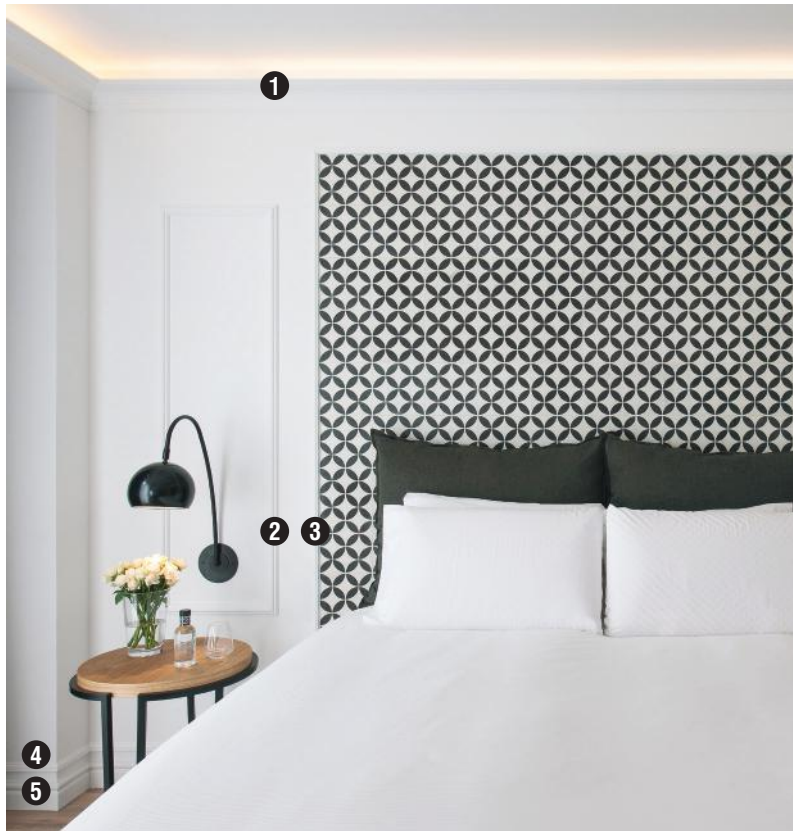

6 CX197 pg. 36

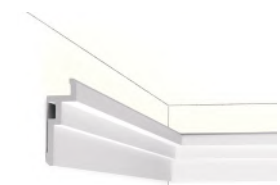

7 CX196 pg. 36



8 PX198 pg. 63



1 C391 pg. 46



2 C393 pg. 50

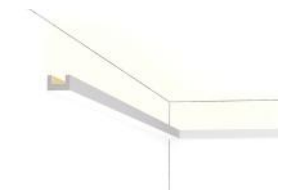

3 CX190 pg. 35



4 W216 pg. 76



5 SX207 pg. 72



6 W130 pg. 75



7 DX174-2300 pg. 89



8 SX191 pg. 71







1 C392

pg. 48



2 C390

pg. 43



3 P7070

pg. 62



4 SX180

pg. 70



1 CX190F pg. 35



2 PX198F pg. 63



3 W111F pg. 74



4 W116F pg. 75



5 W119F pg. 75

Advantages

Why you should choose Orac.



PAINTABLE

Primed and easy to finish with any type of quality paint



WATER-RESISTANT

Never gets wet; water-resistant and dimensionally stable



IMPACT RESISTANT

Knock-, shock-, and scratch-resistant



FLEXIBLE

Curved walls and ceilings can be finished elegantly



EASY INSTALLATION

Lightweight and easy-to-install with Orac's DecoFix glues



SUSTAINABLE

Produced with 40% renewable energy, 100% recyclable, no toxic products

Legend

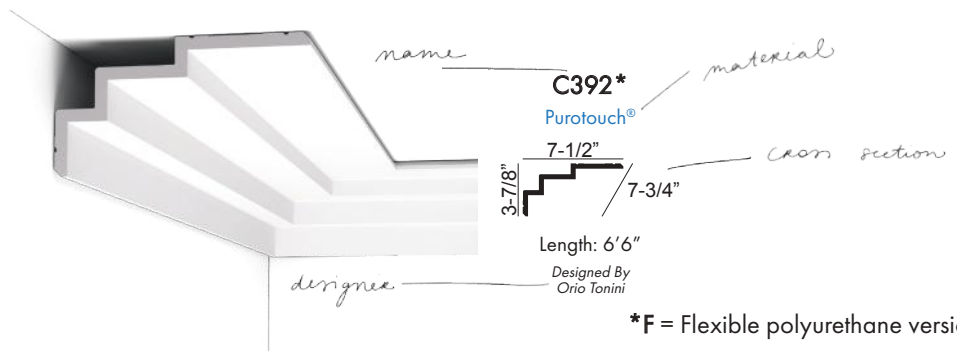

Our indirect lighting solutions are the unseen maestros of ambiance. They are as versatile as they are subtle, designed to enhance every line and curve. So, we encourage you to integrate them as you see fit, for you to create an atmosphere that complements the time of day and the essence of the moment.

Indirect Lighting

Indirect Lighting Profiles

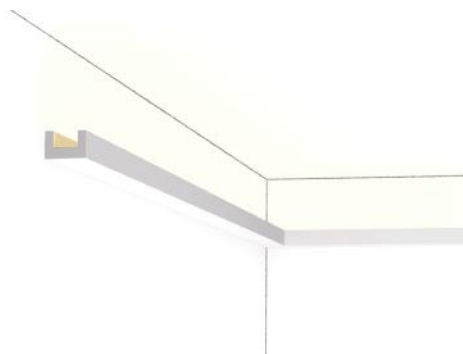

CX190
CX190F (Flexible)

Duropolym[®]



Length: 6'6"

Designed By
Orio Tonini

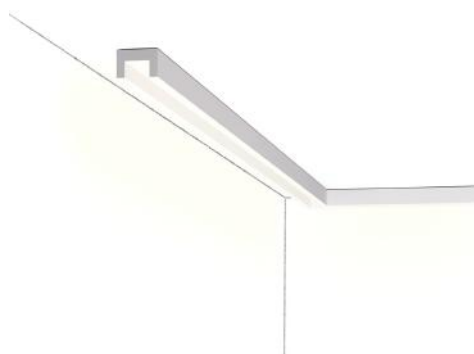

CX190
CX190F (Flexible)

Duropolym[®]



Length: 6'6"

Designed By
Orio Tonini

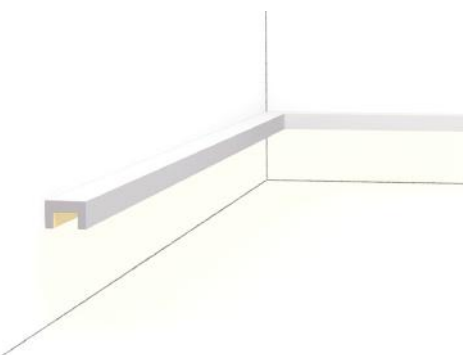

CX190
CX190F (Flexible)

Duropolym[®]



Length: 6'6"

Designed By
Orio Tonini



CX189
CX189F (Flexible)

Duropolym[®]

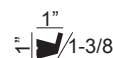

Length: 6'6"

Designed By
Orio Tonini

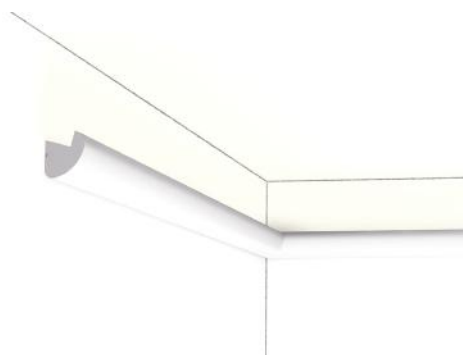

CX188
CX188F (Flexible)

Duropolym[®]



Length: 6'6"

Designed By
Orio Tonini



C380

Purotouch[®]

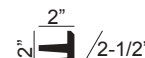

Length: 6'6"

Designed By
Orio Tonini

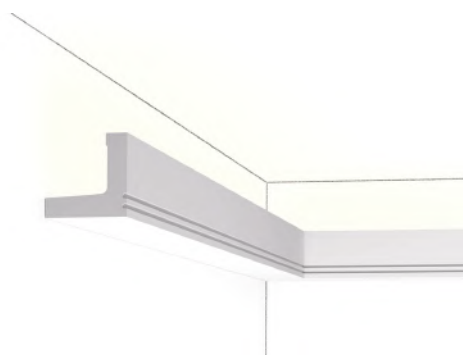

C361

Purotouch[®]

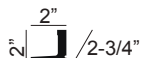

Length: 6'6"

Designed By
Pierre Daems

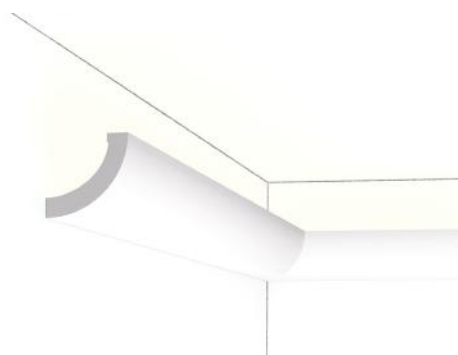

C362

Purotouch[®]



Length: 6'6"

Designed By
Pierre Daems

Purotouch[®] a proprietary polymer blend formulated to create deep reliefs and crisp details.
Duropolym[®] high impact resin blend. Ideally suited for baseboards and chair rails.

Water Resistant Paintable Easy-to-Install Superior Quality Flexible

1-800-631-8375 | For Wholesale Pricing: www.oracdecorusa.com

English measurements converted from metric. Metric is the most accurate. All profiles copyrighted and protected by International Law.

Indirect Lighting Profiles

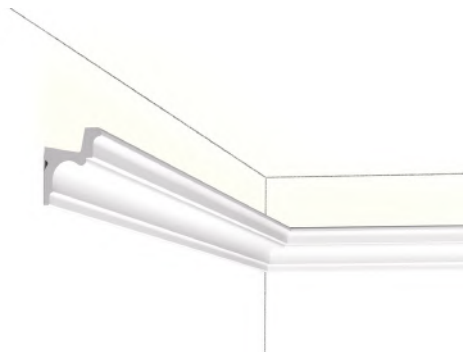

C323
Purotouch®
1-5/8"
2-1/8" / 2-3/4"
Length: 6' 6"
Designed By
Orio Tonini

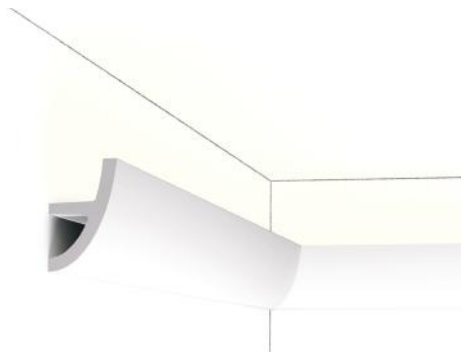

C373
FC373 (Flexible)
Purotouch®
2"
3-1/8" / 3-3/4"
Length: 6' 6"
Designed By
Ulf Moritz

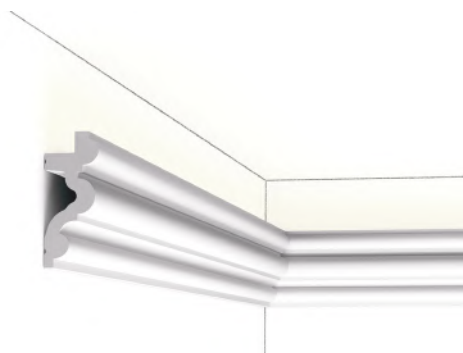

C324
Purotouch®
1-3/8"
3-1/4" / 3-3/4"
Length: 6' 6"
Designed By
Orio Tonini

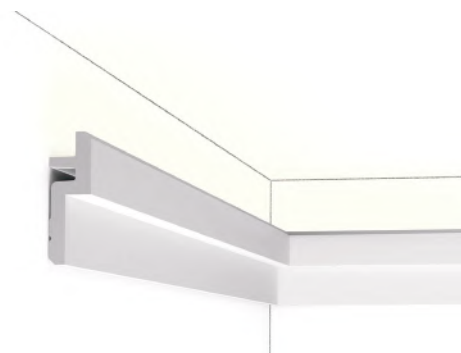

C394
Purotouch®
1-1/4"
3-3/4" / 3-3/4"
Length: 6' 6"
Designed By
Orio Tonini

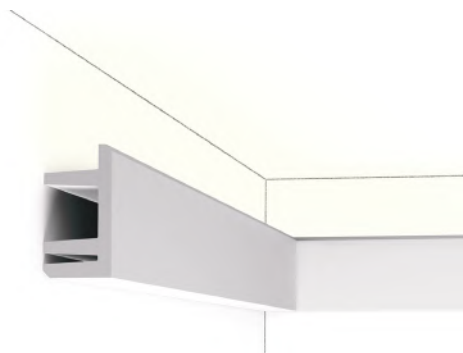

C381
Purotouch®
2"
3-3/4" / 3-3/4"
Length: 6' 6"
Designed By
Orio Tonini



CX197
Duropolymer®
3-5/8"
2" / 4"
Length: 6' 6"
Designed By
Orio Tonini



C390
Purotouch®
3-7/8"
2-3/8" / 4-1/8"
Length: 6' 6"
Designed By
Orio Tonini

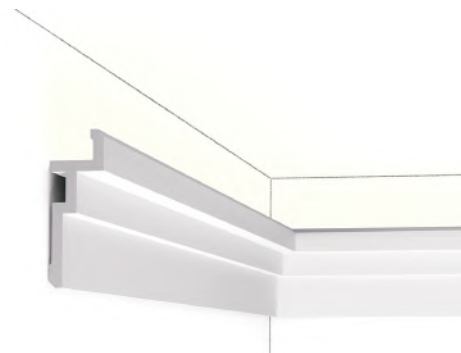

CX196
Duropolymer®
1-5/8"
4-1/2" / 4-5/8"
Length: 6' 6"
Designed By
Orio Tonini

Purotouch® a proprietary polymer blend formulated to create deep reliefs and crisp details.
Duropolymer® high impact resin blend. Ideally suited for baseboards and chair rails.

Water Resistant Paintable Easy-to-Install Superior Quality Flexible

Indirect Lighting Profiles

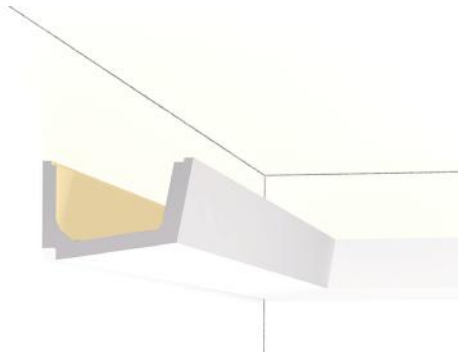

C357
Purotouch®
4-3/8"
2-3/4" / 5"
Length: 6'6"
Designed By
Jacques Verbracht



C382
Purotouch®
2"
5-1/2" / 5"
Length: 6'6"
Designed By
Orio Tonini

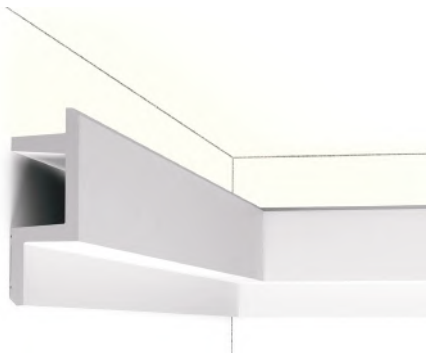

C383
Purotouch®
2"
5-1/2" / 5"
Length: 6'6"
Designed By
Orio Tonini

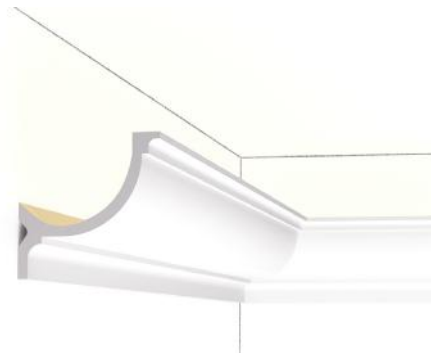

C902
FC902 (Flexible)
Purotouch®
4"
4" / 5-5/8"
Length: 6'6"



C391
Purotouch®
6-1/4"
2-3/8" / 5-7/8"
Length: 6'6"
Designed By
Orio Tonini

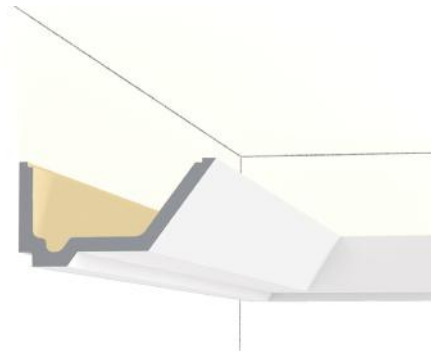

C358
Purotouch®
5-1/2"
2-7/8" / 6"
Length: 6'6"
Designed By
Jacques Verbracht

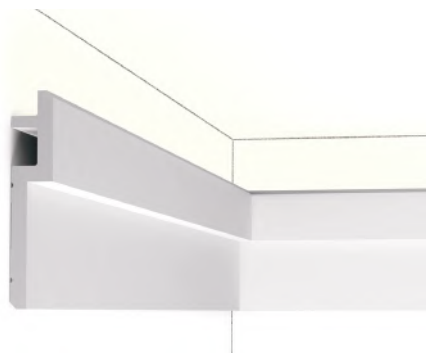

C395
Purotouch®
1-1/4"
6-1/8" / 6-1/8"
Length: 6'6"
Designed By
Orio Tonini



C991
Purotouch®
5-1/2"
4-3/8" / 7"
Length: 6'6"
Designed By
Ulf Moritz

Purotouch® a proprietary polymer blend formulated to create deep reliefs and crisp details.
Duopolymer® high impact resin blend. Ideally suited for baseboards and chair rails.

Water Resistant Paintable Easy-to-Install Superior Quality Flexible

Indirect Lighting Profiles

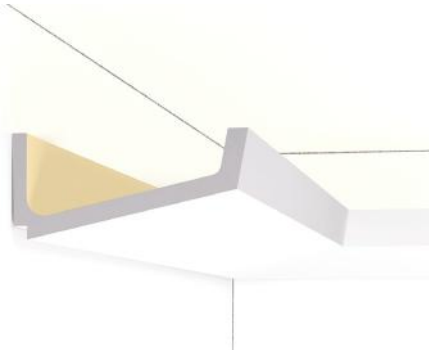

C352
Purotouch®
6-3/4" / 7-1/8"
Length: 6' 6"
Designed By Jacques Verfracht

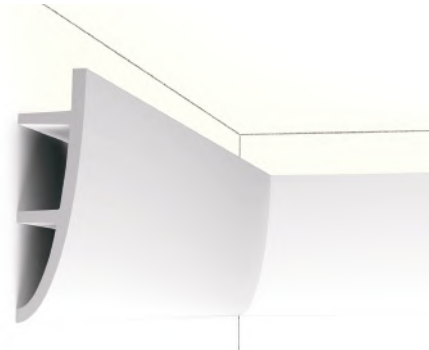

C374
Purotouch®
2" / 7-3/8"
Length: 6' 6"
Designed By Ulf Moritz

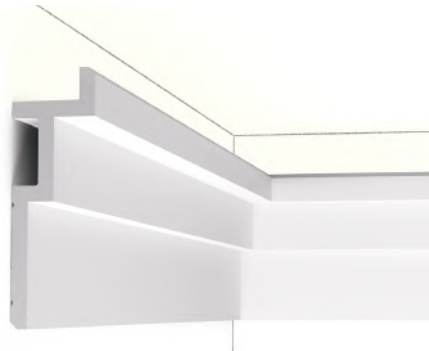

C396
Purotouch®
2-3/8" / 7-1/2"
Length: 6' 6"
Designed By Orio Tonini

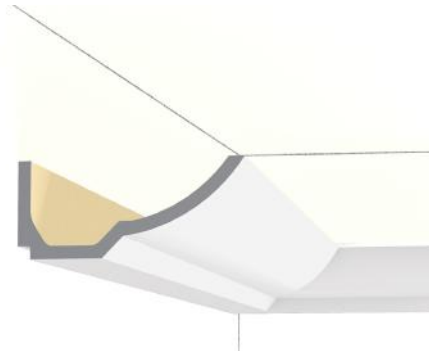

C351
Purotouch®
6-3/4" / 7-1/2"
Length: 6' 6"
Designed By Jacques Verfracht

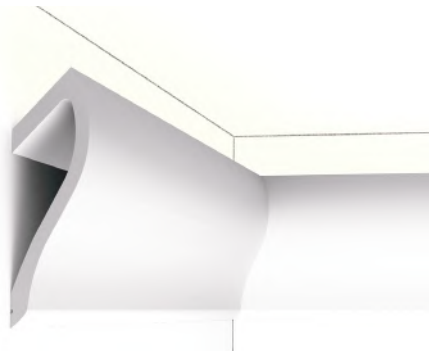

C371
Purotouch®
2-1/4" / 7-1/2"
Length: 6' 6"
Designed By Ulf Moritz

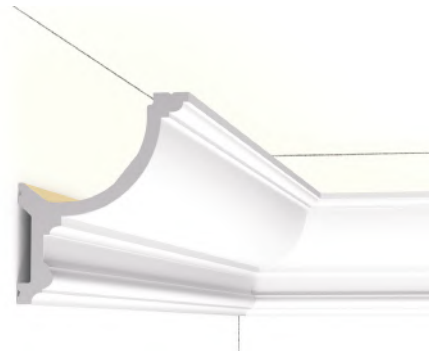

C901
FC901 (Flexible)
Purotouch®
4-7/8" / 7-1/2"
Length: 6' 6"

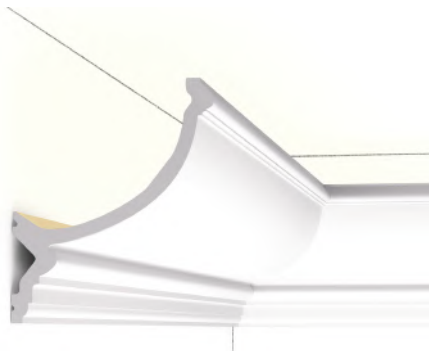

C900
Purotouch®
5-3/4" / 8-5/8"
Length: 6' 6"

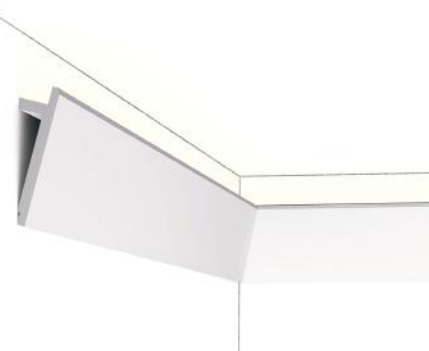

SX179
Duropolymer®
1-1/8" / 3-7/8"
Length: 6' 6"
Designed By Orio Tonini

Purotouch® a proprietary polymer blend formulated to create deep reliefs and crisp details.
Duropolymer® high impact resin blend. Ideally suited for baseboards and chair rails.

Water Resistant Paintable Easy-to-Install Superior Quality Flexible

Cornice Moulding

ORAC
BY OUTWATER

Cornice Moulding

It truly does move us when we look up and see how it softens the strict transition between wall and ceiling. For us, a cornice is about attention to detail, be it from ornate to subtle. We have thought them all through so that there should always be an option that meets your personal aspirations.

Cornice Moulding



C250
FC250 (Flexible)
Purotouch®
5/8" / 7/8"
Length: 6'6"



CX133
Duropolymer®
3/4" / 1-1/8"
Length: 6'6"



CX111
Duropolymer®
5/8" / 1-1/8"
Length: 6'6"



CX132
Duropolymer®
3/4" / 1-1/8"
Length: 6'6"



CX134
Duropolymer®
1-1/8" / 1-1/8"
Length: 6'6"



CX115
Duropolymer®
1-1/8" / 1-1/2"
Length: 6'6"



C230
FC230 (Flexible)
Purotouch®
1-1/8" / 1-5/8"
Length: 6'6"



CX148
Duropolymer®
1-3/4" / 2"
Length: 6'6"

Purotouch® a proprietary polymer blend formulated to create deep reliefs and crisp details.
Duropolymer® high impact resin blend. Ideally suited for baseboards and chair rails.

Water Resistant Paintable Easy-to-Install Superior Quality Flexible

Cornice Moulding



CX110
CX110F (Flexible)

Duopolymer®

1-5/8"
1-3/4" / 2-1/4"

Length: 6'6"



C360

Purotouch®

2-3/8"
7/8" / 2-3/8"

Length: 6'6"



CX160

Duopolymer®

1-1/2"
1/2"

Length: 6'6"



CX161

Duopolymer®

2-3/4"
1/2"

Length: 6'6"



C260

Duopolymer®

1-7/8"
1-5/8" / 2-3/8"

Length: 6'6"



CX109

CX109F (Flexible)

Duopolymer®

1-3/4"
1-3/4" / 2-3/8"

Length: 6'6"



C322

Purotouch®

1-5/8"
2" / 2-1/2"

Length: 6'6"



C215

FC215 (Flexible)

Purotouch®

1-7/8"
1-7/8" / 2-5/8"

Length: 6'6"

Purotouch® a proprietary polymer blend formulated to create deep reliefs and crisp details.
Duopolymer® high impact resin blend. Ideally suited for baseboards and chair rails.

Water Resistant | Paintable | Easy-to-Install | Superior Quality | Flexible

1-800-631-8375 | For Wholesale Pricing: www.oracdecorusa.com

English measurements converted from metric. Metric is the most accurate. All profiles copyrighted and protected by International Law.

Cornice Moulding



CX112
Duropolymer®
1-1/2"
2-1/8" / 2-5/8"
Length: 6' 6"

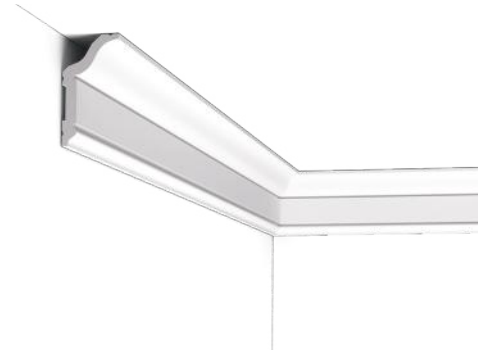

CX141
Duropolymer®
1-1/4"
2-3/8" / 2-5/8"
Length: 6' 6"



CX124
CX124F (Flexible)
Duropolymer®
1-7/8"
1-7/8" / 2-5/8"
Length: 6' 6"



C323
Purotouch®
1-5/8"
2-1/8" / 2-3/4"
Length: 6' 6"
Designed By
Orio Tonini



C602
Purotouch®
2"
2-1/8" / 2-7/8"
Length: 6' 6"



CX108
Duropolymer®
2-1/8"
2-1/8" / 3"
Length: 6' 6"



C200
Purotouch®
2-1/4"
2-1/2" / 3-3/8"
Length: 6' 6"



C212
Purotouch®
1-3/4"
2-7/8" / 3-3/8"
Length: 6' 6"

Purotouch® a proprietary polymer blend formulated to create deep reliefs and crisp details.
Duropolymer® high impact resin blend. Ideally suited for baseboards and chair rails.

Water Resistant Paintable Easy-to-Install Superior Quality Flexible

Cornice Moulding



CX176
Duropolymer®
1-5/8"
3-1/8" / 3-1/2"
Length: 6'6"



CX177
Duropolymer®
2-3/8"
2-3/4" / 3-5/8"
Length: 6'6"



C394
Purotouch®
1-1/4"
3-3/4" / 3-3/4"
Length: 6'6"
*Designed By
Orio Tonini*



C325
FC325 (Flexible)
Purotouch®
2-1/2"
2-3/4" / 3-3/4"
Length: 6'6"



CX100
CX100F (Flexible)
Duropolymer®
2-3/4"
2-3/4" / 3-3/4"
Length: 6'6"



C356
Purotouch®
3-7/8"
3/4" / 3-7/8"
Length: 6'6"
*Designed By
Jacques Verfracht*



CX197
Duropolymer®
2"
3-5/8" / 4"
Length: 6'6"
*Designed By
Orio Tonini*



C390
Purotouch®
3-7/8"
2-3/8" / 4-1/8"
Length: 6'6"
*Designed By
Orio Tonini*

Purotouch® a proprietary polymer blend formulated to create deep reliefs and crisp details.
Duropolymer® high impact resin blend. Ideally suited for baseboards and chair rails.

Water Resistant | Paintable | Easy-to-Install | Superior Quality | Flexible

1-800-631-8375 | For Wholesale Pricing: www.oracdecorusa.com

English measurements converted from metric. Metric is the most accurate. All profiles copyrighted and protected by International Law.

Cornice Moulding



C321
FC321 (Flexible)

Duropolym[®]

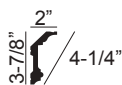

Length: 6' 6"



C355

Purotouch[®]

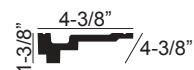

Length: 6' 6"

Designed By
Jacques Verfracht



CX123
CX123F (Flexible)

Purotouch[®]

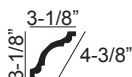

Length: 6' 6"

Designed By
Jacques Verfracht



CX199
CX199F (Flexible)

Duropolym[®]

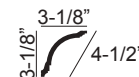

Length: 6' 6"



C240
FC240 (Flexible)

Duropolym[®]

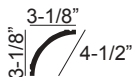

Length: 6' 6"



C213
FC213 (Flexible)

Purotouch[®]

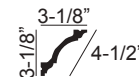

Length: 6' 6"

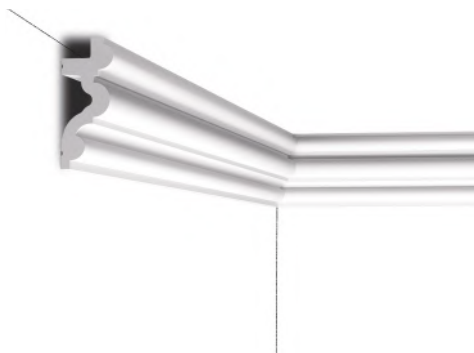

C324

Purotouch[®]



Length: 6' 6"

Designed By
Orio Tonini



CX196

Duropolym[®]

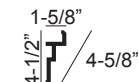

Length: 6' 6"

Designed By
Orio Tonini

Purotouch[®] a proprietary polymer blend formulated to create deep reliefs and crisp details.
Duropolym[®] high impact resin blend. Ideally suited for baseboards and chair rails.

Water Resistant Paintable Easy-to-Install Superior Quality Flexible

Cornice Moulding



C400
Purotouch®
3-7/8" / 4-5/8"
Length: 6'6"



CX126
Duropolymer®
3-3/8" / 4-3/4"
Length: 6'6"



C201
Purotouch®
1-7/8" / 4-7/8"
Length: 6'6"



CX127
CX127F (Flexible)
Duropolymer®
3-3/4" / 5-1/8"
Length: 6'6"



CX129
Duropolymer®
3-3/4" / 5-1/8"
Length: 6'6"



CX192
Duropolymer®
2-3/8" / 5-1/4"
Length: 6'6"



C326
Purotouch®
3-1/2" / 5-3/8"
Length: 6'6"



C220
FC220 (Flexible)
Purotouch®
4-5/8" / 5-3/8"
Length: 6'6"

Purotouch® a proprietary polymer blend formulated to create deep reliefs and crisp details.
Duropolymer® high impact resin blend. Ideally suited for baseboards and chair rails.

Water Resistant Paintable Easy-to-Install Superior Quality Flexible

1-800-631-8375 | For Wholesale Pricing: www.oracdecorusa.com

English measurements converted from metric. Metric is the most accurate. All profiles copyrighted and protected by International Law.

Cornice Moulding



C402
FC402 (Flexible)

Purotouch®

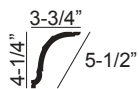

Length: 6'6"



C304

Purotouch®

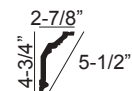

Length: 6'6"



C902
FC902 (Flexible)

Purotouch®



Length: 6'6"



C391

Purotouch®

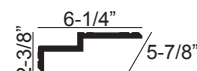

Length: 6'6"



C341
FC341 (Flexible)

Purotouch®

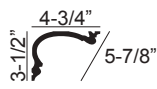

Length: 6'6"



C339
FC339 (Flexible)

Purotouch®

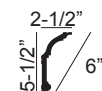

Length: 6'6"



C303

Purotouch®



Length: 6'6"



C395

Purotouch®



Length: 6'6"

Designed By
Orio Tonini

Purotouch® a proprietary polymer blend formulated to create deep reliefs and crisp details.
Duropolymer® high impact resin blend. Ideally suited for baseboards and chair rails.

Water Resistant Paintable Easy-to-Install Superior Quality Flexible

Cornice Moulding



C211
FC211 (Flexible)
Purotouch®
4-3/8"
4-5/8" / 6-1/4"
Length: 6'6"



C305
Purotouch®
6-1/8"
1-7/8" / 6-1/4"
Length: 6'6"
Additional options available.
See page 48



C333
FC333 (Flexible)
Purotouch®
4-3/8"
4-3/4" / 6-3/8"
Length: 6'6"



CX106
CX106F (Flexible)
Duropolymer®
4-5/8"
4-5/8" / 6-3/8"
Length: 6'6"



CX107
Duropolymer®
4-5/8"
4-5/8" / 6-3/8"
Length: 6'6"
Designed By
Jacques Verfracht



C353
Purotouch®
6-1/2"
1-1/8" / 6-1/2"
Length: 6'6"



C216
FC216 (Flexible)
Purotouch®
5-1/4"
4-5/8" / 6-3/4"
Length: 6'6"



C991
Purotouch®
4-3/8"
5-1/2" / 7"
Length: 6'6"

Purotouch® a proprietary polymer blend formulated to create deep reliefs and crisp details.
Duropolymer® high impact resin blend. Ideally suited for baseboards and chair rails.

Water Resistant Paintable Easy-to-Install Superior Quality Flexible

1-800-631-8375 | For Wholesale Pricing: www.oracdecorusa.com

English measurements converted from metric. Metric is the most accurate. All profiles copyrighted and protected by International Law.

Cornice Moulding



C991
Purotouch®
4-3/8" 5-1/2" / 7"
Length: 6'6"



C217
FC217 (Flexible)
Purotouch®
4" 6-1/8" / 7-1/4"
Length: 6'6"



C217
FC217 (Flexible)
Purotouch®
4" 6-1/8" / 7-1/4"
Length: 6'6"



C396
Purotouch®
2-3/8" 7-1/4" / 7-1/2"
Length: 6'6"
Designed By
Orio Tonini



C901
FC901 (Flexible)
Purotouch®
4-7/8" 5-7/8" / 7-1/2"
Length: 6'6"



C305 + C213
Purotouch®
6-1/8" 5" / 7-5/8"
Length: 6'6"



C392
Purotouch®
3-7/8" 7-1/2" / 7-3/4"
Length: 6'6"
Designed By
Orio Tonini



C327
Purotouch®
5-5/8" 6-1/4" / 8-3/8"
Length: 6'6"

Purotouch® a proprietary polymer blend formulated to create deep reliefs and crisp details.
Duropolymer® high impact resin blend. Ideally suited for baseboards and chair rails.

Water Resistant Paintable Easy-to-Install Superior Quality Flexible

Cornice Moulding



Purotouch® a proprietary polymer blend formulated to create deep reliefs and crisp details.
Duropolymer® high impact resin blend. Ideally suited for baseboards and chair rails.

Water Resistant Paintable Easy-to-Install Superior Quality Flexible

1-800-631-8375 | For Wholesale Pricing: www.oracdecorusa.com

English measurements converted from metric. Metric is the most accurate. All profiles copyrighted and protected by International Law.

Cornice Moulding



C334
FC334 (Flexible)
Purotouch®
7-3/4"
5-7/8" / 9-1/2"
Length: 6'6"



C393
Purotouch®
8-1/4"
5-7/8" / 9-3/4"
Length: 6'6"

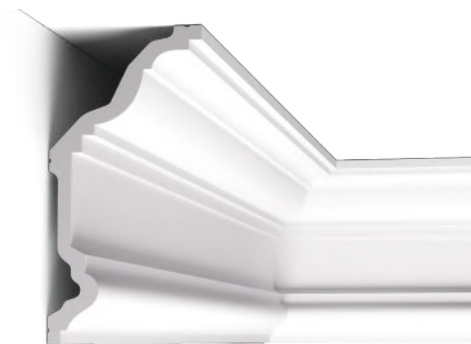

C332
Purotouch®
4-1/2"
9" / 9-7/8"
Length: 6'6"



C332
Purotouch®
9"
4-1/2" / 9-7/8"
Length: 6'6"



C308
Purotouch®
2-1/2"
9-3/4" / 9-7/8"
Length: 6'6"



C422
Purotouch®
7-5/8"
6-1/2" / 10"
Length: 6'6"



C338
Purotouch®
7-1/4"
7-1/4" / 10"
Length: 6'6"



C338A
Purotouch®
7-1/4"
7-1/4" / 10"
Length: 6'6"

Purotouch® a proprietary polymer blend formulated to create deep reliefs and crisp details.
Duropolymer® high impact resin blend. Ideally suited for baseboards and chair rails.

Water Resistant Paintable Easy-to-Install Superior Quality Flexible

Cornice Moulding



C338B

Purotouch®

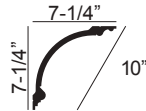

Length: 6'6"

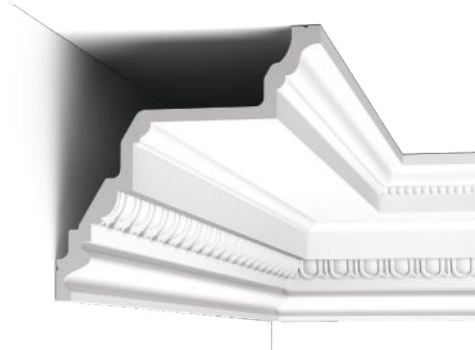

C307

Purotouch®



Length: 6'6"

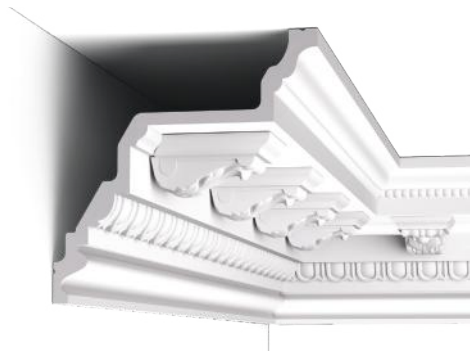

C307 + C-307A

Purotouch®



Length: 6'6"

Corbels typically spaced 4" - 6" apart

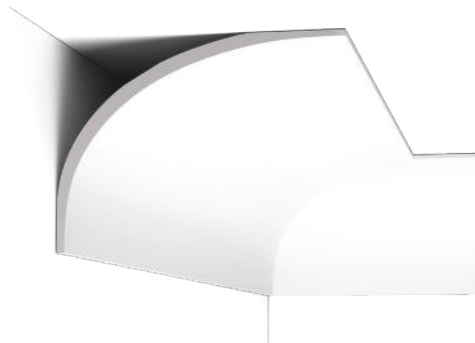

C990

Purotouch®

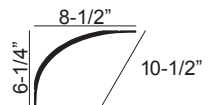

Length: 6'6"

Designed By
Xavier Donck

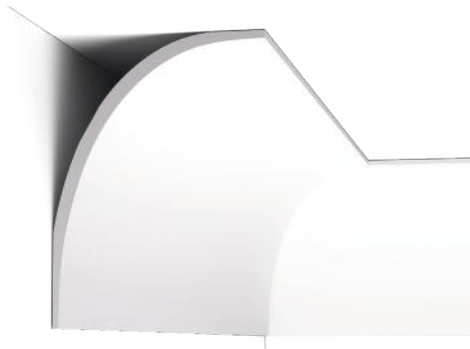

C990

Purotouch®

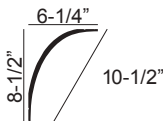

Length: 6'6"

Designed By
Xavier Donck



C991 + 2x P9900

Purotouch®

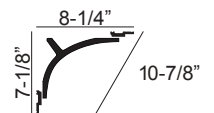

Length: 6'6"

Designed By
Ulf Moritz



C991 + 2x P9900

Purotouch®

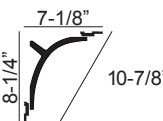

Length: 6'6"

Designed By
Ulf Moritz



C340

Purotouch®

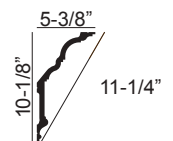

Length: 6'6"

Purotouch® a proprietary polymer blend formulated to create deep reliefs and crisp details.
Duropolymers® high impact resin blend. Ideally suited for baseboards and chair rails.

Water Resistant | Paintable | Easy-to-Install | Superior Quality | Flexible

1-800-631-8375 | For Wholesale Pricing: www.oracdecorusa.com

English measurements converted from metric. Metric is the most accurate. All profiles copyrighted and protected by International Law.

Cornice Moulding

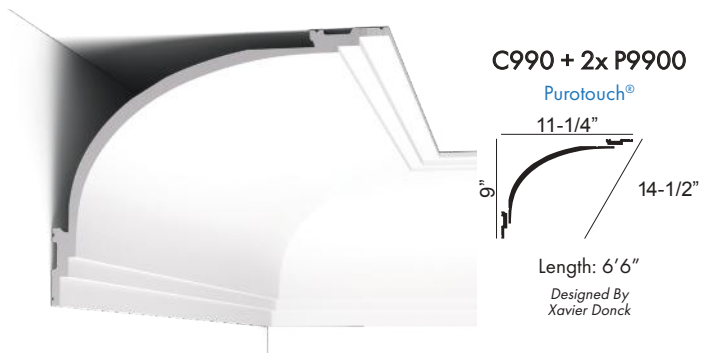
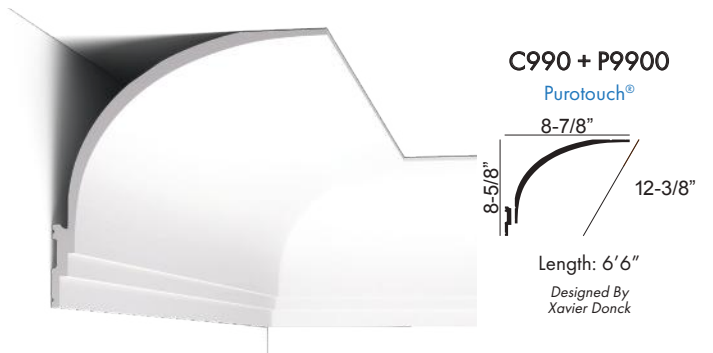
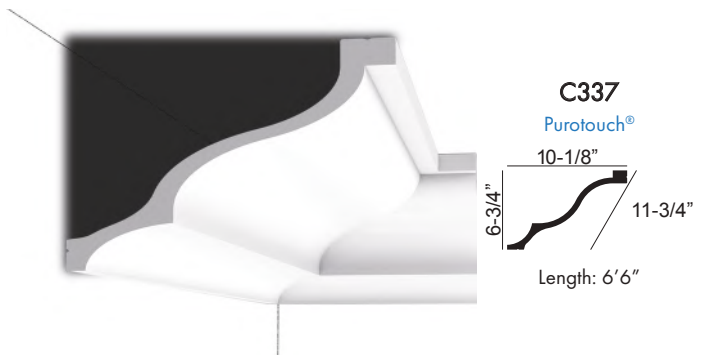
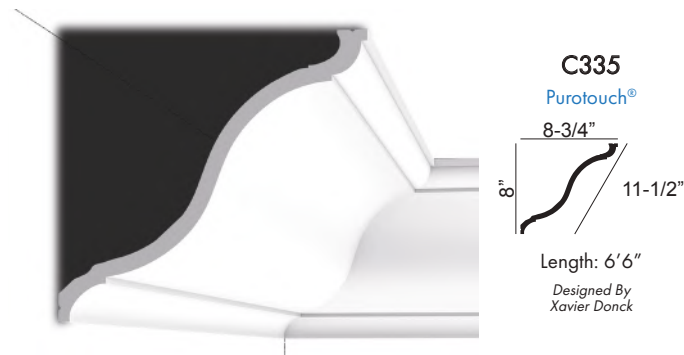
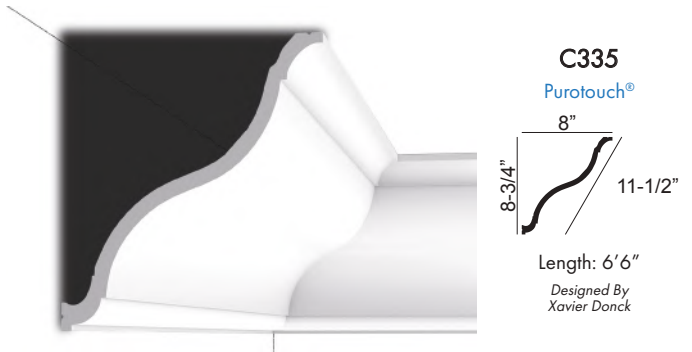

Purotouch® a proprietary polymer blend formulated to create deep reliefs and crisp details.
Duropolymer® high impact resin blend. Ideally suited for baseboards and chair rails.

Water Resistant Paintable Easy-to-Install Superior Quality Flexible

Cornice Moulding

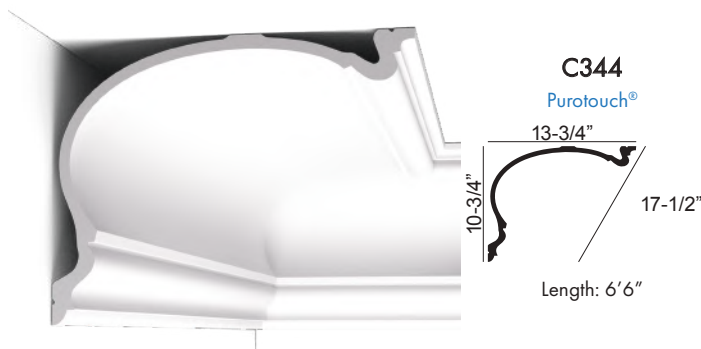
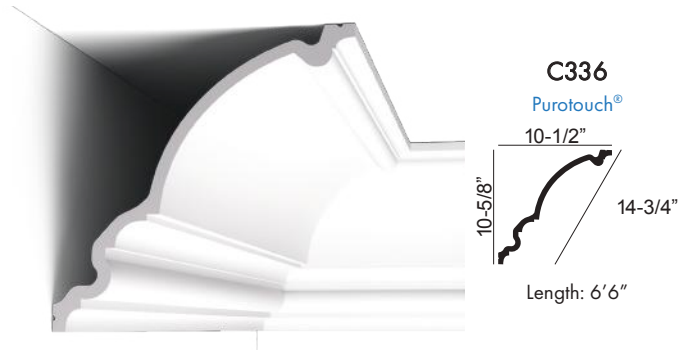

Build Up

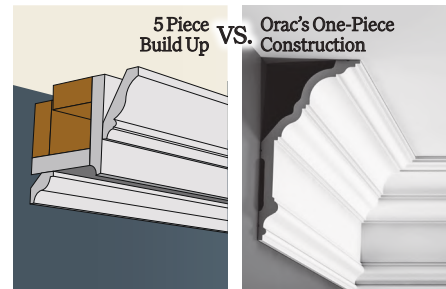

Purotouch® a proprietary polymer blend formulated to create deep reliefs and crisp details.
Duropolymer® high impact resin blend. Ideally suited for baseboards and chair rails.

Water Resistant Paintable Easy-to-Install Superior Quality Flexible

1-800-631-8375 | For Wholesale Pricing: www.oracdecorusa.com

English measurements converted from metric. Metric is the most accurate. All profiles copyrighted and protected by International Law.

Durofoam® Cornice Moulding



CB500
Durofoam®
3/4"
1-1/8" / 1-1/8"
Length: 6'6"



CB530
Durofoam®
5/8"
1-1/8" / 1-1/4"
Length: 6'6"



CB520
Durofoam®
1-3/8"
1-3/8" / 2"
Length: 6'6"



CB531
Durofoam®
1"
1-5/8" / 2"
Length: 6'6"



CB501
Durofoam®
1-3/8"
1-5/8" / 2-1/8"
Length: 6'6"



CB510
Durofoam®
1-5/8"
1-5/8" / 2-1/4"
Length: 6'6"



CB521
Durofoam®
2"
2-3/8" / 2-3/4"
Length: 6'6"



CB523
Durofoam®
1-3/4"
2-3/8" / 2-7/8"
Length: 6'6"

Durofoam® a cost-effective extruded lightweight polymer based on a medium-density polystyrene blend.

Water Resistant Paintable Easy-to-Install Superior Quality Flexible

Durofoam® Cornice Moulding



CB502
Durofoam®
1-7/8"
2-3/8" / 3-1/8"
Length: 6'6"



CB525
Durofoam®
2-3/8"
2-1/2" / 3-1/2"
Length: 6'6"



CB522
Durofoam®
2-5/8"
2-5/8" / 3-7/8"
Length: 6'6"



CB511
Durofoam®
2-5/8"
2-5/8" / 3-7/8"
Length: 6'6"



CB503
Durofoam®
3-5/8"
3-1/4" / 4-7/8"
Length: 6'6"



CB524
Durofoam®
3-1/2"
3-1/2" / 5"
Length: 6'6"



CB512
Durofoam®
3-7/8"
3-7/8" / 5-3/8"
Length: 6'6"



PB513
Durofoam®
1-3/8"
5/8" / 5/8"
Length: 6'6"

Durofoam® a cost-effective extruded lightweight polymer based on a medium-density polystyrene blend.

Water Resistant Paintable Easy-to-Install Superior Quality Flexible

1-800-631-8375 | For Wholesale Pricing: www.oracdecorusa.com

English measurements converted from metric. Metric is the most accurate. All profiles copyrighted and protected by International Law.

Curtain Profiles

Make your curtain hardware disappear

Our innovative curtain profiles are the perfect addition to your space. These state-of-the-art mouldings were designed to be attached to the ceiling and allow space for curtain rods and drapes to be hidden behind. It is also possible to use these profiles to hide lighting and other hardware. When installed, these mouldings offer an uninterrupted perimeter around the room and are a beautiful transition from wall to ceiling.

Curtain Profiles



C394
Purotouch®
 $1\text{-}1/4''$ $3\text{-}3/4''$ / $3\text{-}3/4''$
 Length: 6'6"
 Designed By
 Orio Tonini



CX197
Duropolymer®
 $2''$ $3\text{-}5/8''$ / $4''$
 Length: 6'6"
 Designed By
 Orio Tonini



C390
Purotouch®
 $2\text{-}3/8''$ $3\text{-}7/8''$ / $4\text{-}1/8''$
 Length: 6'6"
 Designed By
 Orio Tonini



CX196
Duropolymer®
 $1\text{-}5/8''$ $4\text{-}1/2''$ / $4\text{-}5/8''$
 Length: 6'6"
 Designed By
 Orio Tonini



C395
Purotouch®
 $1\text{-}1/4''$ $6\text{-}1/8''$ / $6\text{-}1/8''$
 Length: 6'6"



C391
Purotouch®
 $2\text{-}3/8''$ $6\text{-}1/4''$ / $5\text{-}7/8''$
 Length: 6'6"
 Designed By
 Orio Tonini



C341
FC341 (Flexible)
Purotouch®
 $3\text{-}1/2''$ $4\text{-}3/4''$ / $5\text{-}7/8''$
 Length: 6'6"



C991
Purotouch®
 $4\text{-}3/8''$ $5\text{-}1/2''$ / $7''$
 Length: 6'6"
 Designed By
 Ulf Moritz

Purotouch® a proprietary polymer blend formulated to create deep reliefs and crisp details.
 Duropolymer® high impact resin blend. Ideally suited for baseboards and chair rails.

Water Resistant Paintable Easy-to-Install Superior Quality Flexible

1-800-631-8375 | For Wholesale Pricing: www.oracdecorusa.com

English measurements converted from metric. Metric is the most accurate. All profiles copyrighted and protected by International Law.

Curtain Profiles



C396
Purotouch®
7-1/4" / 7-1/2"
2-3/8"
Length: 6'6"
Designed By
Orio Tonini



C392
Purotouch®
7-1/2" / 7-3/4"
3-7/8"
Length: 6'6"
Designed By
Orio Tonini



C342
Purotouch®
7-1/2" / 9-1/4"
5-1/2"
Length: 6'6"



C343
Purotouch®
9-7/8" / 12-3/8"
7-1/2"
Length: 6'6"



Purotouch® a proprietary polymer blend formulated to create deep reliefs and crisp details.
Duropolymer® high impact resin blend. Ideally suited for baseboards and chair rails.

Water Resistant Paintable Easy-to-Install Superior Quality Flexible

Panel Moulding

ORAC
BY OUTWATER

Panel Moulding

Empty walls are in need of shape and dimension, which is why we love to entertain ideas with these versatile accents. By using our panel mouldings, harmony comes into play, a sense of proportion that is balanced and pleasing to the eye.



Panel Moulding

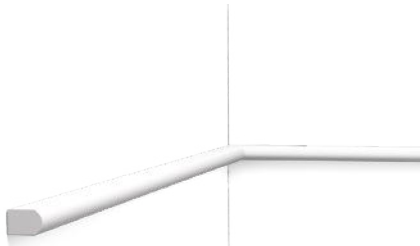

PX209
PX209F (Flexible)

Duropolym[®]



Length: 6' 6"

Designed By
Orio Tonini

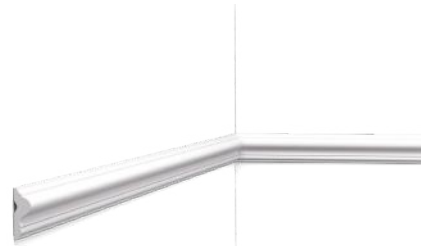

PX201
PX201F (Flexible)

Duropolym[®]



Length: 6' 6"



P9050
FP9050 (Flexible)

Purotouch[®]



Length: 6' 6"



PX103
PX103F (Flexible)

Duropolym[®]



Length: 6' 6"



PX116
Duropolym[®]



Length: 6' 6"



P5021
FP5021 (Flexible)

Purotouch[®]



Length: 6' 6"



PX117
Duropolym[®]



Length: 6' 6"



PX120
PX120F (Flexible)

Duropolym[®]



Length: 6' 6"

Purotouch[®] a proprietary polymer blend formulated to create deep reliefs and crisp details.
Duropolym[®] high impact resin blend. Ideally suited for baseboards and chair rails.

Water Resistant Paintable Easy-to-Install Superior Quality Flexible

Panel Moulding



P8030
FP8030 (Flexible)

Purotouch®



Length: 6'6"

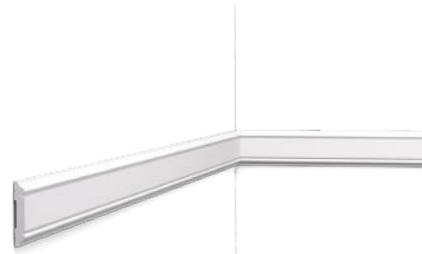

PX144
PX144F (Flexible)

Duopolymer®



Length: 6'6"



P1020

Purotouch®



Length: 6'6"



P9040

Purotouch®



Length: 6'6"



P4020
FP4020 (Flexible)

Purotouch®



Length: 6'6"

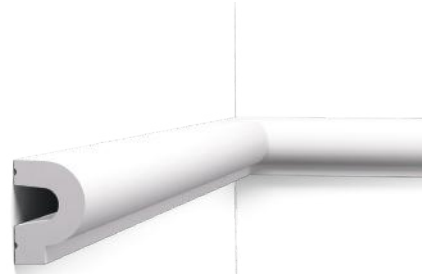

P8060

Purotouch®



Length: 6'6"



PX175
PX175F (Flexible)

Duopolymer®



Length: 6'6"

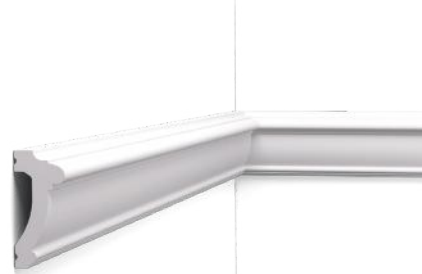

PX113

Duopolymer®



Length: 6'6"

Purotouch® a proprietary polymer blend formulated to create deep reliefs and crisp details.
Duopolymer® high impact resin blend. Ideally suited for baseboards and chair rails.

Water Resistant Paintable Easy-to-Install Superior Quality Flexible

Panel Moulding

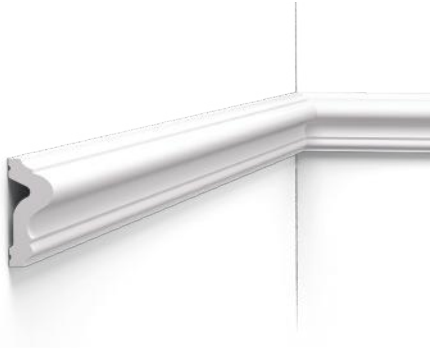

P8020
FP8020 (Flexible)

Purotouch®



Length: 6' 6"

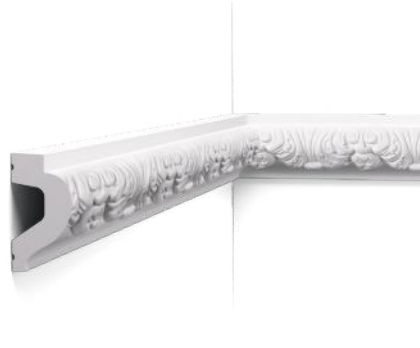

P3020
FP3020 (Flexible)

Purotouch®



Length: 6' 6"



P6020

Purotouch®



Length: 6' 6"

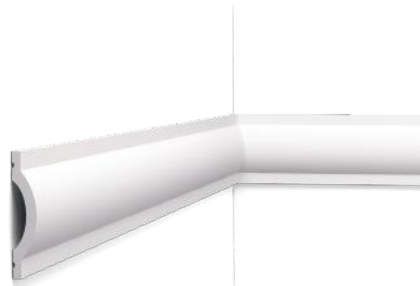

P9901

Purotouch®



Length: 6' 6"



P7070
FP7070 (Flexible)

Purotouch®



Length: 6' 6"



PX202
PX202F (Flexible)

Duopolymer®



Length: 6' 6"



PX102
Duopolymer®



Length: 6' 6"



P9900
FP9900 (Flexible)

Purotouch®



Length: 6' 6"

Purotouch® a proprietary polymer blend formulated to create deep reliefs and crisp details.
Duopolymer® high impact resin blend. Ideally suited for baseboards and chair rails.

Water Resistant Paintable Easy-to-Install Superior Quality Flexible

Panel Moulding

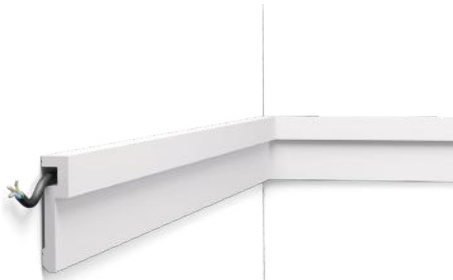

PX198
PX198F (Flexible)

Duopolymer®



Length: 6'6"

Designed By
Orio Tonini

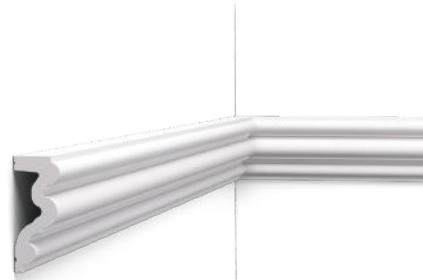

P4025
FP4025 (Flexible)

Purotouch®



Length: 6'6"

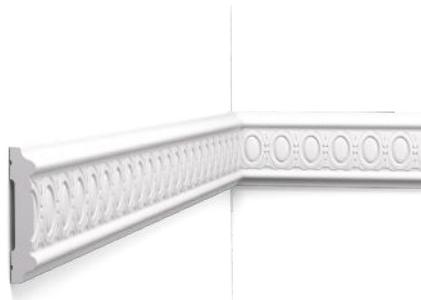

P7030

Purotouch®



Length: 6'6"



P9010
FP9010 (Flexible)

Purotouch®



Length: 6'6"



P9020

Purotouch®



Length: 6'6"



P8040
FP8040 (Flexible)

Purotouch®



Length: 6'6"

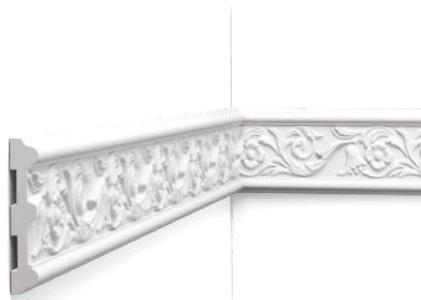

P7020

Purotouch®



Length: 6'6"

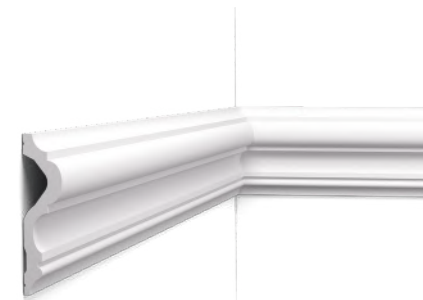

P8050
FP8050 (Flexible)

Purotouch®



Length: 6'6"

Purotouch® a proprietary polymer blend formulated to create deep reliefs and crisp details.
Duopolymer® high impact resin blend. Ideally suited for baseboards and chair rails.

Water Resistant Paintable Easy-to-Install Superior Quality Flexible

1-800-631-8375 | For Wholesale Pricing: www.oracdecorusa.com

English measurements converted from metric. Metric is the most accurate. All profiles copyrighted and protected by International Law.

Panel Moulding

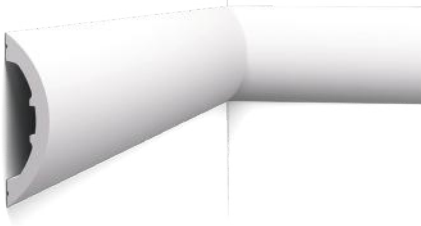

P3070
Purotouch®
1-1/4"
4-7/8"
Length: 6' 6"
Designed By
Ulf Moritz

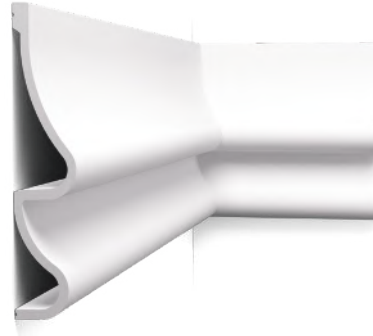

P3071
Purotouch®
3"
14-5/8"
Length: 6' 6"
Designed By
Ulf Moritz



Purotouch® a proprietary polymer blend formulated to create deep reliefs and crisp details.
Duropolymer® high impact resin blend. Ideally suited for baseboards and chair rails.

Water Resistant Paintable Easy-to-Install Superior Quality Flexible

Panel Moulding

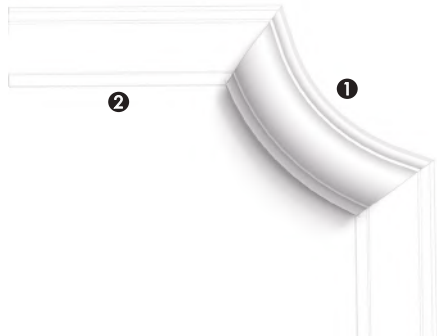

1 P-801C
Purotouch®
Height: 4-3/8"
Projection: 1"
Length: 7-3/4"



1 P-4020A
Purotouch®
Height: 3-5/8"
Projection: 1-1/8"
Length: 6-1/2"

2 P8020
Purotouch®
Height: 2-3/8"
Projection: 1"
Length: 6'6"

2 P4020
Purotouch®
Height: 2"
Projection: 1-1/8"
Length: 6'6"

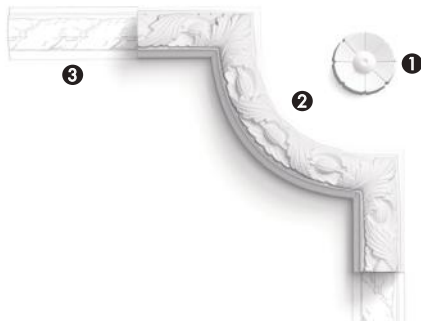

1 P-20
Duropolymer®
Height: 2-3/8"
Projection: 3/8"
Length: 2-3/8"



1 P3020A
Purotouch®
Height: 16-3/4"
Projection: 1-5/8"
Length: 16-3/4"

2 P-101A
Purotouch®
Height: 9-5/8"
Projection: 1"
Length: 9-5/8"

2 P3020
Purotouch®
Height: 2-3/8"
Projection: 1-1/4"
Length: 6'6"

3 P1020

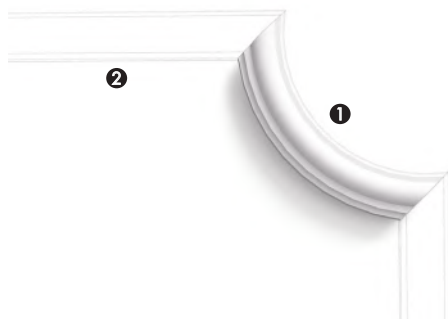

1 PX120A
Duropolymer®
Height: 3-1/2"
Projection: 3/8"
Length: 7-1/2"

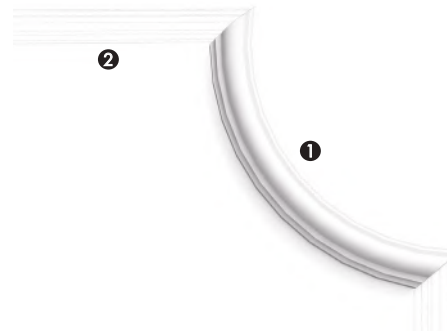

1 PX103A
Duropolymer®
Height: 2-5/8"
Projection: 1/2"
Length: 7-1/2"

2 PX120
Duropolymer®
Height: 1-5/8"
Projection: 3/4"
Length: 6'6"

2 PX103
Duropolymer®
Height: 1"
Projection: 1/2"
Length: 6'6"

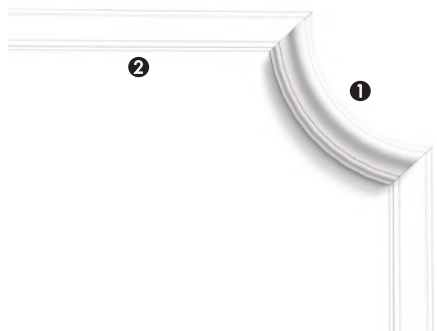

1 P-8030C
Duropolymer®
Height: 2-5/8"
Projection: 1/2"
Length: 7-1/2"



P8030D
Duropolymer®
Height: 5-3/8"
Projection: 5/8"
Length: 5-3/8"

2 P8030
Purotouch®
Height: 9-5/8"
Projection: 1"
Length: 6'6"

Purotouch® a proprietary polymer blend formulated to create deep reliefs and crisp details.
Duropolymer® high impact resin blend. Ideally suited for baseboards and chair rails.

Water Resistant Paintable Easy-to-Install Superior Quality Flexible

1-800-631-8375 | For Wholesale Pricing: www.oracdecorusa.com















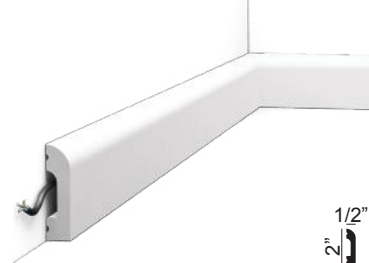

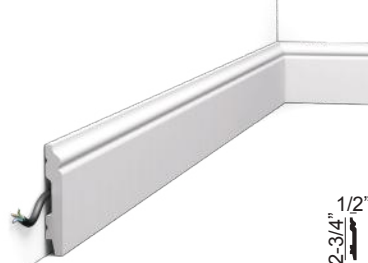







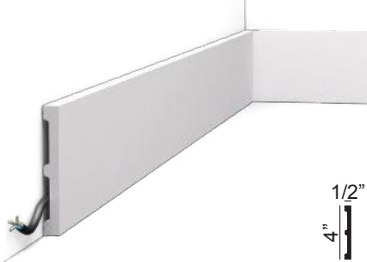

English measurements converted from metric. Metric is the most accurate. All profiles copyrighted and protected by International Law.

Baseboard Moulding

Crafting seamless transitions from floor to wall, from the elegantly ornate to the gracefully understated. We pay meticulous attention to every detail in every design so you can find options that match your vision.

3 Baseboard Families

CHOOSE YOUR STYLE. GET CREATIVE

	SQUARE 	CASCADE 	CONTOUR 
SMALL	SX162 SX162F (Flexible)  1-5/8" 	SX182 SX182F (Flexible)  2" 	SX165 SX165F (Flexible)  2-3/4" 
	SX157 SX157F (Flexible)  2-5/8" 	SX183 SX183F (Flexible)  3" 	SX173 SX173F (Flexible)  4" 
BIG	SX163 SX163F (Flexible)  4" 	SX184 SX184F (Flexible)  4-3/8" 	SX118 SX118F (Flexible)  5-3/8" 
	SX171  3-7/8" 	SX185  4-3/4" 	SX186  5-1/2" 

Baseboard Moulding



SX194
SX194F (Flexible)
Duropolymer®
3/4" 3/8"
Length: 6' 6"



SX162
SX162F (Flexible)
Duropolymer®
1-5/8" 3/8"
Length: 6' 6"



SX182
SX182F (Flexible)
Duropolymer®
2" 1/2"
Length: 6' 6"

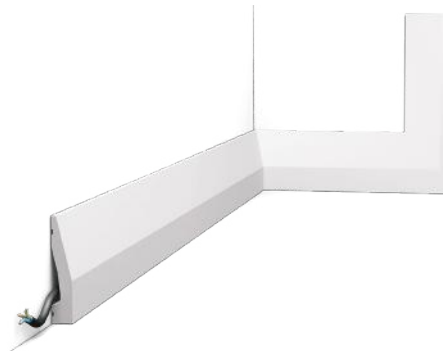

SX159
SX159F (Flexible)
Duropolymer®
2-3/8" 1/2"
Length: 6' 6"

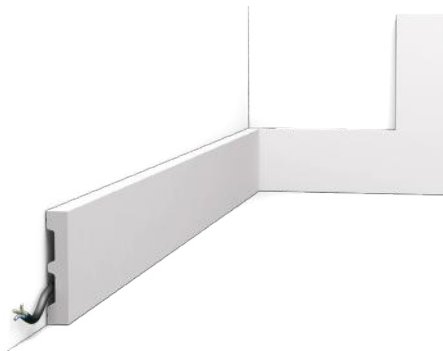

SX157
SX157F (Flexible)
Duropolymer®
2-5/8" 1/2"
Length: 6' 6"



SX165
SX165F (Flexible)
Duropolymer®
2-3/4" 1/2"
Length: 6' 6"



SX125
SX125F (Flexible)
Duropolymer®
2-3/4" 1/2"
Length: 6' 6"



SX183
SX183F (Flexible)
Duropolymer®
3" 1/2"
Length: 6' 6"

Purotouch® a proprietary polymer blend formulated to create deep reliefs and crisp details.
Duropolymer® high impact resin blend. Ideally suited for baseboards and chair rails.

Water Resistant Paintable Easy-to-Install Superior Quality Flexible

Baseboard Moulding



SX187
SX187F (Flexible)
Duropolymer®
1/2"
3"
Length: 6'6"



SX122
Duropolymer®
7/8"
3-1/8"
Length: 6'6"



SX195
SX195F (Flexible)
Duropolymer®
3/4"
3-1/8"
Length: 6'6"



SX172
SX172F (Flexible)
Duropolymer®
1/2"
3-3/8"
Length: 6'6"



SX179
Duropolymer®
1-1/8"
3-7/8" / 3-7/8"
Length: 6'6"
*Designed By
Orio Tonini*



SX137
SX137F (Flexible)
Duropolymer®
5/8"
3-7/8"
Length: 6'6"



SX171
Duropolymer®
7/8"
3-7/8"
Length: 6'6"



SX173
SX173F (Flexible)
Duropolymer®
5/8"
4"
Length: 6'6"

Purotouch® a proprietary polymer blend formulated to create deep reliefs and crisp details.
Duropolymer® high impact resin blend. Ideally suited for baseboards and chair rails.

Water Resistant Paintable Easy-to-Install Superior Quality Flexible

Baseboard Moulding



SX163
SX163F (Flexible)

Duropolym[®]
 $\frac{1}{2}$ "
 4"
 Length: 6'6"



SX105
SX105F (Flexible)

Duropolym[®]
 $\frac{1}{2}$ "
 4-1/4"
 Length: 6'6"



SX155
SX155F (Flexible)

Duropolym[®]
 1"
 4-1/8"
 Length: 6'6"



SX184
SX184F (Flexible)

Duropolym[®]
 $\frac{1}{2}$ "
 4-3/8"
 Length: 6'6"



SX185
Duropolym[®]

1"
 4-3/4"
 Length: 6'6"



SX180
SX180F (Flexible)

Duropolym[®]
 $\frac{5}{8}$ "
 4-3/4"
 Length: 6'6"



SX138
SX138F (Flexible)

Duropolym[®]
 $\frac{5}{8}$ "
 5-3/8"
 Length: 6'6"



SX118
SX118F (Flexible)

Duropolym[®]
 $\frac{3}{4}$ "
 5-3/8"
 Length: 6'6"

Purotouch[®] a proprietary polymer blend formulated to create deep reliefs and crisp details.
 Duropolym[®] high impact resin blend. Ideally suited for baseboards and chair rails.

Water Resistant Paintable Easy-to-Install Superior Quality Flexible

Baseboard Moulding

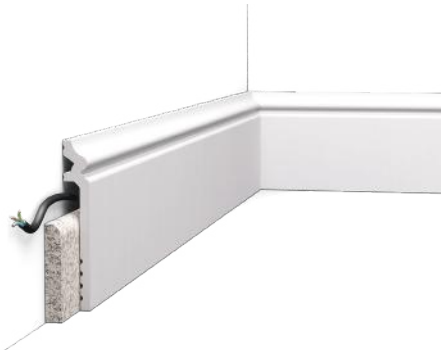

SX186
Duropolymer®
7/8"
5-1/2"
Length: 6'6"



SX104
SX104F (Flexible)
Duropolymer®
5/8"
5-7/8"
Length: 6'6"

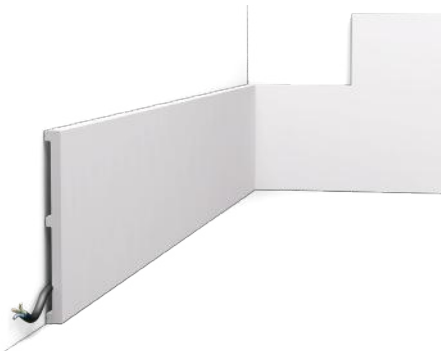

SX168
Duropolymer®
1/2"
5-7/8"
Length: 6'6"



SX212
Duropolymer®
1/2"
6-3/4"
Length: 6'6"

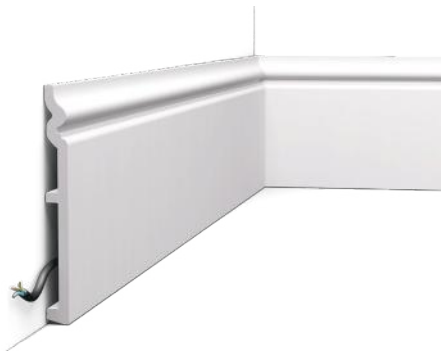

SX206
Duropolymer®
3/4"
7-1/8"
Length: 6'6"



SX181
Duropolymer®
7/8"
7-7/8"
Length: 6'6"



SX156
Duropolymer®
5/8"
7-7/8"
Length: 6'6"



SX191
Duropolymer®
7/8"
8-1/4"
Length: 6'6"

Purotouch® a proprietary polymer blend formulated to create deep reliefs and crisp details.
Duropolymer® high impact resin blend. Ideally suited for baseboards and chair rails.

Water Resistant | Paintable | Easy-to-Install | Superior Quality | Flexible

1-800-631-8375 | For Wholesale Pricing: www.oracdecorusa.com

English measurements converted from metric. Metric is the most accurate. All profiles copyrighted and protected by International Law.

Baseboard Moulding

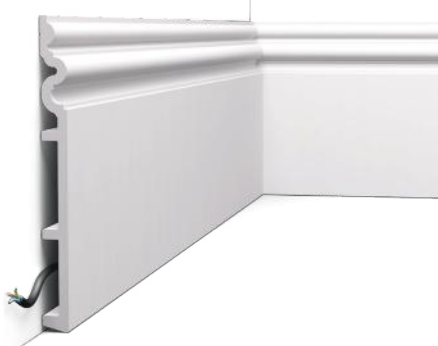

SX193
Duropolymer®
7/8"
9-7/8"
Length: 6'6"
Designed By
Orio Tonini

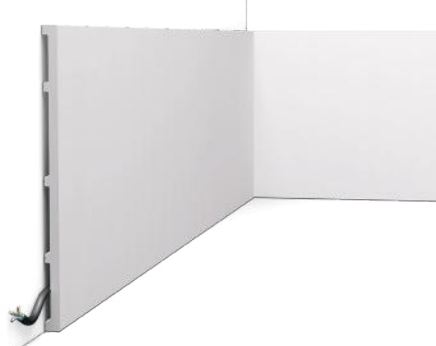

SX207
SX207F (Flexible)
Duropolymer®
1/2"
9-7/8"
Length: 6'6"



Purotouch® a proprietary polymer blend formulated to create deep reliefs and crisp details.
Duropolymer® high impact resin blend. Ideally suited for baseboards and chair rails.

Water Resistant
Paintable
Easy-to-Install
Superior Quality
Flexible

3D Wall Coverings

ORAC
BY OUTWATER

3D Wall Covering

We invite you to experience the extraordinary with our 3D wall coverings. Captivating sculptural landscapes, these masterpieces redefine your walls, inviting touch and exploration. Discover a range of bold and subtle designs, each a testament to the art of interior transformation.



ACOUSTIC CONTRIBUTION - CLASS E

In combination with other elements, Purotouch® has a positive effect on the overall sound quality, absorbing up to 25% of conversational sounds.



3D Wall Covering



W108
W108F (Flexible)
Zig Zag
Purotouch®

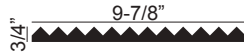

Length: 6' 6"
Designed By
Orlo Tonini



W109
W109F (Flexible)
Valley
Purotouch®



Length: 6' 6"
Designed By
Orlo Tonini



W110
W110F (Flexible)
Hill
Purotouch®

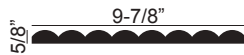

Length: 6' 6"
Designed By
Orlo Tonini



W111
W111F (Flexible)
Bar
Purotouch®



Length: 6' 6"
Designed By
Orlo Tonini



W112
Ridge
Purotouch®



Length: 6' 6"
Designed By
Orlo Tonini



W113
Cobble
Purotouch®

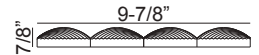

Length: 6' 6"
Designed By
Orlo Tonini



W114
W114F (Flexible)
Valley XL
Purotouch®



Length: 6' 6"
Designed By
Orlo Tonini



W115
Slope
Purotouch®



Length: 6' 6"

Purotouch® a proprietary polymer blend formulated to create deep reliefs and crisp details.
Duropolymer® high impact resin blend. Ideally suited for baseboards and chair rails.

Water Resistant Paintable Easy-to-Install Superior Quality Flexible

3D Wall Covering



W116
W116F (Flexible)
Bar XL

Purotouch®

9-7/8"



Length: 6'6"

Designed By
Orio Tonini

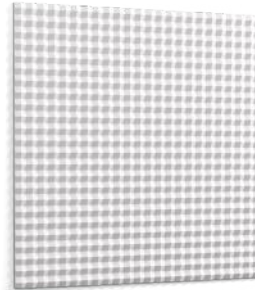

W117
Slope

Purotouch®

39-3/8"

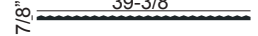

Length: 39-3/8"

Designed By
Orio Tonini



W119
W119F (Flexible)
Bar Mix

Purotouch®

9-7/8"



Length: 6'6"

Designed By
Orio Tonini



W130
Chevron

Purotouch®

9-7/8"



Length: 6'6"

Designed By
Orio Tonini

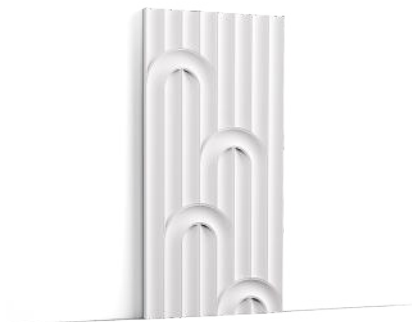

W212
Valley Loop

Purotouch®

9-7/8"



Length: 6'6"

Designed By
Orio Tonini

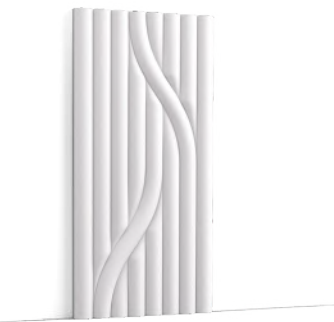

W213
Hill Trace

Purotouch®

9-7/8"



Length: 6'6"

Designed By
Orio Tonini



W214
W214F (Flexible)
Hill Bead XL

Purotouch®

15-3/4"



Length: 6'6"

Designed By
Orio Tonini

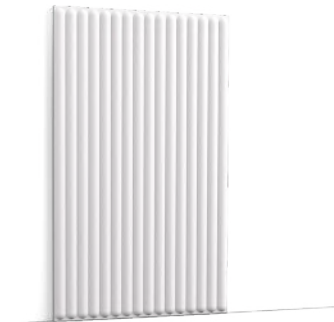

W215
Hill Bead

Purotouch®

19-3/4"

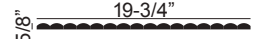

Length: 6'6"

Purotouch® a proprietary polymer blend formulated to create deep reliefs and crisp details.
Duropolymer® high impact resin blend. Ideally suited for baseboards and chair rails.

Water Resistant Paintable Easy-to-Install Superior Quality Flexible

1-800-631-8375 | For Wholesale Pricing: www.oracdecorusa.com

English measurements converted from metric. Metric is the most accurate. All profiles copyrighted and protected by International Law.

3D Wall Covering



W216
Matrix
Purotouch®



Length: 6'6"
Designed By
Orio Tonini



W217
Pillow
Purotouch®

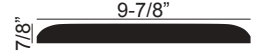

Length: 6'6"
Designed By
Orio Tonini



W218
Quilt
Purotouch®

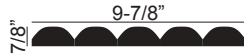

Length: 6'6"
Designed By
Orio Tonini

A-Side
Primed



DOUBLE-SIDED



B-Side
Non-Primed

WX204 (L: 6'6")
WX204-2600 (L: 8'6")
Ripple
Duropolymer®



Length: 6'6" or 8'6"

A-Side
Primed



DOUBLE-SIDED



B-Side
Non-Primed

WX205 (L: 6'6")
WX205-2600 (L: 8'6")
WX205F (Flexible- L: 6'6")
Track
Duropolymer®



Length: 6'6" or 8'6"

Purotouch® a proprietary polymer blend formulated to create deep reliefs and crisp details.
Duropolymer® high impact resin blend. Ideally suited for baseboards and chair rails.

Water Resistant Paintable Easy-to-Install Superior Quality Flexible

3D Wall Covering

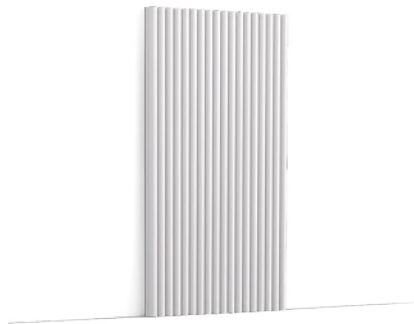

WX210 (L: 6'6")
WX210-2600 (L: 8'6")
WX210F (Flexible- L: 6'6")
Reed
Duropolymer®
10"
1/2"
Length: 6'6" or 8'6"



WX211 (L: 6'6")
WX211-2600 (L: 8'6")
WX211F (Flexible- L: 6'6")
Flute
Duropolymer®
10"
5/8"
Length: 6'6" or 8'6"

Time Saving Accessories



1
CX190
CX190F (Flexible)
Duropolymer®
1-1/8"
3/4"
Length: 6'6"
Designed By
Orio Tonini



2
SX194
SX194F (Flexible)
Duropolymer®
3/8"
3/4"
Length: 6'6"



3
PX209
PX209F (Flexible)
Duropolymer®
3/4"
3/8"
Length: 6'6"
Designed By
Orio Tonini



Great For Outlets

The SX194 profile is the perfect profile to provide a clean and professional appearance around a power outlet.



Dividing Mouldings

Create an elegant divide between 3D Wall Covering styles with these profiles. Also perfect for wainscoting.



Flexible

Flexible variants allow you to create curves and archs, allowing for more versatile wallscape designs.

Purotouch® a proprietary polymer blend formulated to create deep reliefs and crisp details.
Duropolymer® high impact resin blend. Ideally suited for baseboards and chair rails.

Water Resistant Paintable Easy-to-Install Superior Quality Flexible

1-800-631-8375 | For Wholesale Pricing: www.oracdecorusa.com

English measurements converted from metric. Metric is the most accurate. All profiles copyrighted and protected by International Law.

3D Wall Covering



3D Wall Covering



W100
Rombus
Purotouch®
10-1/8"
5-7/8"
Projection: 1-1/8"



W101
Trapezium
Purotouch®
13-5/8"
5-7/8"
Projection: 1-1/8"



W102
Cubi 1
Purotouch®
13-1/8"
13-1/8"
Projection: 1"



W103
Cubi 2
Purotouch®
13-1/8"
13-1/8"
Projection: 1"



W105
Rombus
Purotouch®
13-5/8"
11-3/4"
Projection: 1-1/8"



W106
Envelope
Purotouch®
13-1/8"
13-1/8"
Projection: 1-1/8"
Designed By
Orio Tonini



W107
Circle
Purotouch®
13-1/8"
13-1/8"
Projection: 1-1/8"
Designed By
Orio Tonini

Purotouch® a proprietary polymer blend formulated to create deep reliefs and crisp details.
Duopolymer® high impact resin blend. Ideally suited for baseboards and chair rails.

Water Resistant Paintable Easy-to-Install Superior Quality Flexible

Ceiling medallions, with or without floral designs, bring your ceiling to life and are a great way to break up larger ceiling surfaces. You can choose repetitive decorative elements for playful effects or combine them with mirror lighting to add a modern touch. Rosettes can also be applied to walls. The possibilities are endless, so let your imagination run wild.

Ceiling Medallions



Ceiling Medallions



R-10
Purotouch®
Diameter: \varnothing 5-7/8"
Projection: 1-5/8"
Cut Max Diameter: \varnothing 3/4"
+



R-11
Purotouch®
Diameter: \varnothing 7-1/2"
Projection: 1-3/8"
Cut Max Diameter: \varnothing 1-1/8"
+



R-12
Purotouch®
Diameter: \varnothing 7-5/8"
Projection: 3/4"
Cut Max Diameter: \varnothing 3/8"



R-07
Purotouch®
Diameter: \varnothing 10-1/4"
Projection: 1-1/8"
Cut Max Diameter: \varnothing 2"



R-13
Purotouch®
Diameter: \varnothing 11"
Projection: 1-1/4"
Cut Max Diameter: \varnothing 1"
+



R-14
Purotouch®
Diameter: \varnothing 13"
Projection: 1-1/8"
Cut Max Diameter: \varnothing 1"
+



R-08
Purotouch®
Diameter: \varnothing 15"
Projection: 1-5/8"
Cut Max Diameter: \varnothing 2"



R-31
Purotouch®
Diameter: \varnothing 15-1/8"
Projection: 1-1/8"
Cut Max Diameter: \varnothing 1-3/8"
+

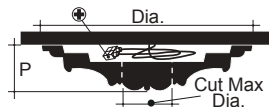

Purotouch® a proprietary polymer blend formulated to create deep reliefs and crisp details.
Duropolymer® high impact resin blend. Ideally suited for baseboards and chair rails.

Water Resistant | Paintable | Easy-to-Install | Superior Quality | Flexible

1-800-631-8375 | For Wholesale Pricing: www.oracdecorusa.com

English measurements converted from metric. Metric is the most accurate. All profiles copyrighted and protected by International Law.

Ceiling Medallions



R-17
Purotouch®
Diameter: \varnothing 18*1/2"
Projection: 1-3/8"
Cut Max Diameter: \varnothing 2-1/2"
+



R-09
Purotouch®
Diameter: \varnothing 19-1/8"
Projection: 1-1/2"
Cut Max Diameter: \varnothing 2-3/8"
+



R-18
Purotouch®
Diameter: \varnothing 19-1/4"
Projection: 1-7/8"
Cut Max Diameter: \varnothing 2-3/4"



R-46
Purotouch®
Diameter: \varnothing 21-1/8"
Projection: 1-5/8"
Cut Max Diameter: \varnothing 1-1/8"
+



R-66
Purotouch®
Diameter: \varnothing 21-1/2"
Projection: 1"
Cut Max Diameter: \varnothing 16-7/8"



R-76
Purotouch®
Diameter: \varnothing 24-3/8"
Projection: 1-5/8"
Cut Max Diameter: \varnothing 4-1/8"



R-77
Purotouch®
Diameter: \varnothing 24-3/8"
Projection: 1-5/8"
Cut Max Diameter: \varnothing 4-1/8"



R-52
Purotouch®
Diameter: \varnothing 27-3/8"
Projection: 1-7/8"
Cut Max Diameter: \varnothing 4-7/8"
+

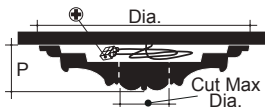

Purotouch® a proprietary polymer blend formulated to create deep reliefs and crisp details.
Duropolymer® high impact resin blend. Ideally suited for baseboards and chair rails.

Water Resistant Paintable Easy-to-Install Superior Quality Flexible

Ceiling Medallions



R-73
Purotouch®
Diameter: \varnothing 27-1/2"
Projection: 2-3/8"
Cut Max Diameter: \varnothing 3-1/8"
+



R-23
Purotouch®
Diameter: \varnothing 28"
Projection: 1-3/4"
Cut Max Diameter: \varnothing 2-3/8"
+



R-40
Purotouch®
Diameter: \varnothing 29-3/8"
Projection: 1-1/4"
Cut Max Diameter: \varnothing 3-7/8"
+



R-27
Purotouch®
Diameter: \varnothing 29-1/2"
Projection: 1-3/4"
Cut Max Diameter: \varnothing 3-1/2"



R-22
Purotouch®
Diameter: \varnothing 20-7/8"
Width: 30-1/2"
Projection: 1-3/8"



R-24
Purotouch®
Diameter: \varnothing 31-1/8"
Projection: 2-3/8"
Cut Max Diameter: \varnothing 3-1/8"



R-64
Purotouch®
Diameter: \varnothing 37-1/2"
Projection: 1-7/8"
Cut Max Diameter: \varnothing 2-3/4"
+



Purotouch® a proprietary polymer blend formulated to create deep reliefs and crisp details.
Duropolymers® high impact resin blend. Ideally suited for baseboards and chair rails.

Water Resistant | Paintable | Easy-to-Install | Superior Quality | Flexible

1-800-631-8375 | For Wholesale Pricing: www.oracdecorusa.com

English measurements converted from metric. Metric is the most accurate. All profiles copyrighted and protected by International Law.

Raised Panels

& Wainscoting

Door or wall panels create a feeling of depth, which makes the room appear larger and more interesting than it would if all of the surfaces were flat.

Wainscoting can evoke the atmosphere of stately homes, and tastefully protect your walls. They are equally suitable for both modern and classical homes, and can bring texture to any wall.

Raised Panels & Wainscoting

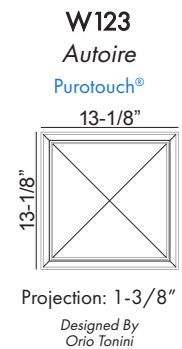
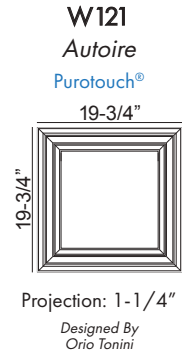
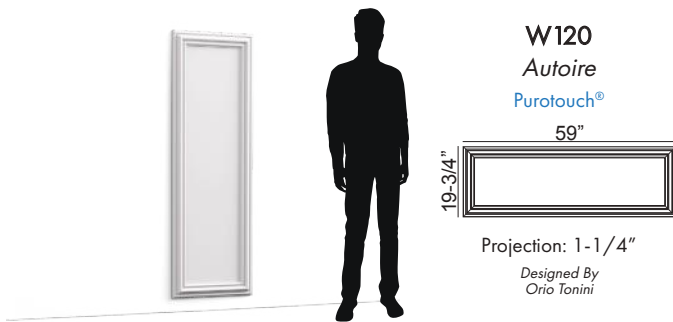

Purotouch® a proprietary polymer blend formulated to create deep reliefs and crisp details.
Duropolymer® high impact resin blend. Ideally suited for baseboards and chair rails.

Water Resistant Paintable Easy-to-Install Superior Quality Flexible



Raised Panels & Wainscoting



D504

Duopolymer®
Height: 8-5/8"
Width: 21-5/8"
Projection: 5/8"

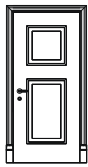

DX121 + D310,
D503, D507

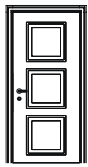

DX119,
3x D503



D506

Duopolymer®
Height: 16-7/8"
Width: 16-7/8"
Projection: 5/8"



D503

Duopolymer®
Height: 21-5/8"
Width: 21-5/8"
Projection: 5/8"



D507

Duopolymer®
Height: 35-5/8"
Width: 21-5/8"
Projection: 5/8"

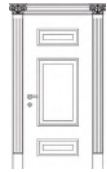

K201L/R + K200,
2x K200, 2x
D504,
D507, D320

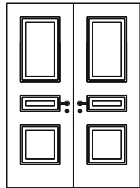

D507, D504,
D503

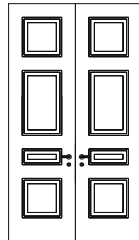

D503, D507,
D504, D503

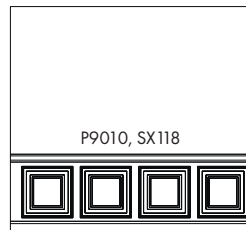

P9010, SX118

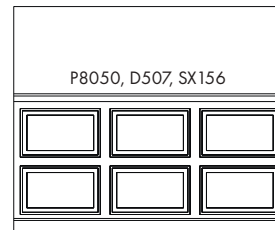

P8050, D507, SX156

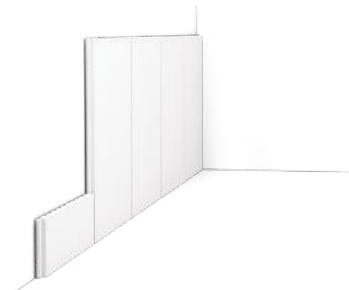

PX147

Height: 6-5/8"
Width: 3/8"
Length: 6'6"

Duopolymer®

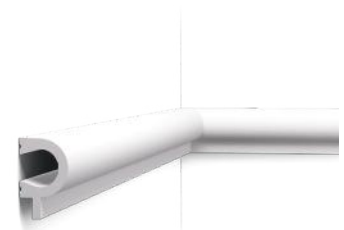

PX169

Height: 2-1/8"
Width: 1-3/8"
Length: 6'6"

Duopolymer®

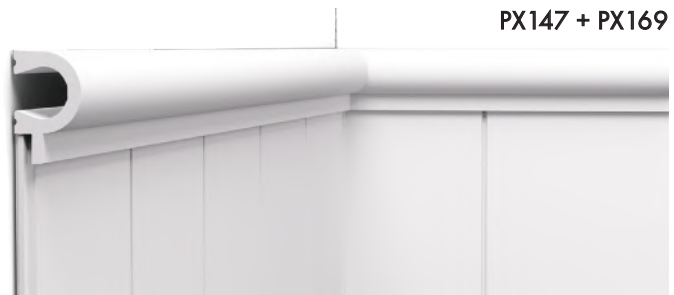

PX147 + PX169

Purotouch® a proprietary polymer blend formulated to create deep reliefs and crisp details.
Duopolymer® high impact resin blend. Ideally suited for baseboards and chair rails.

Water Resistant Paintable Easy-to-Install Superior Quality Flexible

1-800-631-8375 | For Wholesale Pricing: www.oracdecorusa.com

English measurements converted from metric. Metric is the most accurate. All profiles copyrighted and protected by International Law.

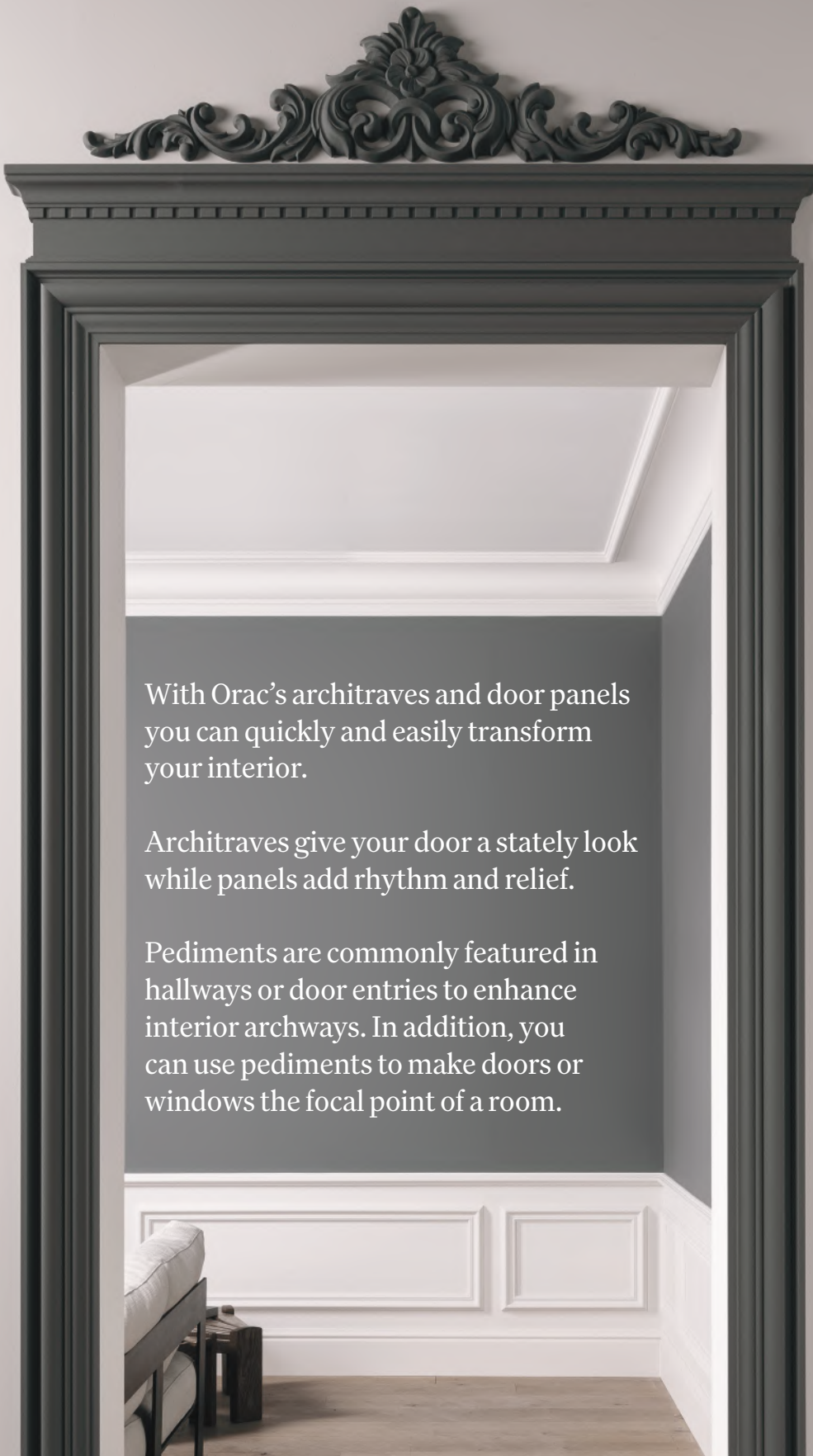

With Orac's architraves and door panels you can quickly and easily transform your interior.

Architraves give your door a stately look while panels add rhythm and relief.

Pediments are commonly featured in hallways or door entries to enhance interior archways. In addition, you can use pediments to make doors or windows the focal point of a room.

Door Frames & Pediments

Door Frames & Pediments



D200

Duopolymer®
Height: 3-3/4"
Projection: 1-1/8"
Length: 3-3/4"

DX119

Duopolymer®
7/8" 3-5/8"
Length: 7'6"

DX174-2300 DX174F (Flexible)

Duopolymer®
7/8" 2-3/8"
Length: 7'6"

DX170-2300

Duopolymer®
1-1/4" 4-5/8"
Length: 7'6"

D310

Duopolymer®
Height: 9-3/4"
Width: 3-3/4"
Projection: 1-1/4"

D340

Duopolymer®
Height: 4-3/4"
Width: 2-3/4"
Projection: 1"

D330LR

Duopolymer®
Height: 6-1/4"
Width: 5"
Projection: 1-5/8"



D402

Purotouch®
Height: 5-7/8"
Width: 4-3/4"
Projection: 2-1/4"

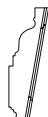

D400

Height: 5-3/4"
Width: 50-1/4"
Projection: 2-1/8"



D400 + D402

Purotouch®

D401

Height: 5-3/4"
Width: 50-1/4"
Projection: 2-1/8"



2x D401 + D402

Purotouch®

Purotouch® a proprietary polymer blend formulated to create deep reliefs and crisp details.
Duopolymer® high impact resin blend. Ideally suited for baseboards and chair rails.

Water Resistant Paintable Easy-to-Install Superior Quality Flexible

1-800-631-8375 | For Wholesale Pricing: www.oracdecorusa.com

English measurements converted from metric. Metric is the most accurate. All profiles copyrighted and protected by International Law.

Door Frames & Pediments

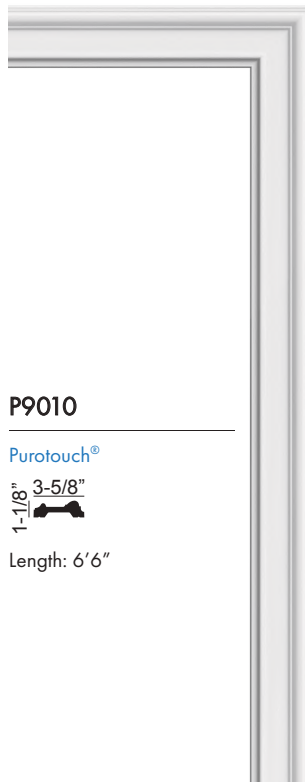

P9010

Purotouch®



Length: 6'6"



D210

Duopolymer®

Height: 3-3/4"
Width: 3-3/4"
Projection: 1-3/8"

DX121

Duopolymer®



Length: 8'

D310

Duopolymer®

Height: 9-3/4"
Width: 3-3/4"
Projection: 1-1/4"

D310

Duopolymer®

Height: 9-3/4"
Width: 3-3/4"
Projection: 1-1/4"



D170

Purotouch®

Height: 9-5/8"
Width: 41-3/4"
Projection: 1-1/4"



Purotouch® a proprietary polymer blend formulated to create deep reliefs and crisp details.
Duopolymer® high impact resin blend. Ideally suited for baseboards and chair rails.

Water Resistant | Paintable | Easy-to-Install | Superior Quality | Flexible

Door Frames & Pediments

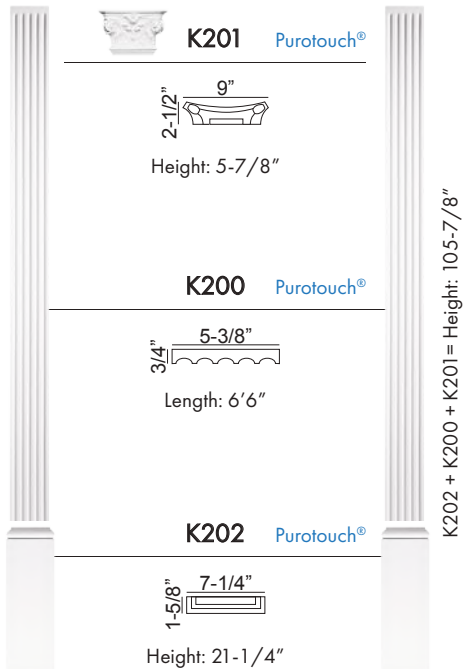

SX162

Duopolymer®

3/8"
1-5/8"

Length: 7'6"

SX157

Duopolymer®

1/2"
2-5/8"

Length: 7'6"

SX159

Duopolymer®

1/2"
2-3/8"

Length: 7'6"

SX163

Duopolymer®

1/2"
4"

Length: 7'6"

SX168

Duopolymer®

1/2"
5-7/8"

Length: 7'6"

Purotouch® a proprietary polymer blend formulated to create deep reliefs and crisp details.
Duopolymer® high impact resin blend. Ideally suited for baseboards and chair rails.

Water Resistant Paintable Easy-to-Install Superior Quality Flexible

1-800-631-8375 | For Wholesale Pricing: www.oracdecorusa.com

English measurements converted from metric. Metric is the most accurate. All profiles copyrighted and protected by International Law.

Columns

& Pilasters

Columns remind us of the ancient world and if you want to add a hint of this to your project, the Orac collection offers plenty to choose from: half and full pillars to many pedestals and shafts.

Pillars can be crowned by capitals available in different designs. This allows you to put together your pillars à la carte to suit your project.

A rectangular wall element, such as a pilaster or wall pillar, is perfect for decorating a book case or breaking up a large plain wall surface. Pilasters at specific distances in a long corridor, for example, add rhythm and dynamics.



Columns & Pilasters

Full Columns

K1112

Duopolymer®

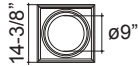

Height: 11-3/4"

K1122

Duopolymer®



Height: 11-3/4"

K1002

Purotouch®

K1102

Purotouch®

Height: 78-1/2"

Height: 79-1/2"



K1112 + K1002 + K1152 = Height: 95-1/4"
K1112 + K1002 + K1132 = Height: 113"
K1122 + K1002 + K1152 = Height: 95-1/4"
K1122 + K1002 + K1132 = Height: 113"



K1112 + K1102 + K1152 = Height: 96-1/4"
K1112 + K1102 + K1132 = Height: 114"
K1122 + K1102 + K1152 = Height: 96-1/4"
K1122 + K1102 + K1132 = Height: 114"



K1152

Duopolymer®



Height: 4-7/8"

K1132

Purotouch®

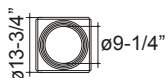

Height: 22-7/8"

Half Columns

K1111

Duopolymer®

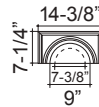

Height: 11-3/4"

K1121

Duopolymer®

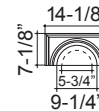

Height: 11-3/4"

K1001

Purotouch®

K1101

Purotouch®

Height: 78-1/2"

Height: 79-1/2"



K1111 + K1001 + K1151 = Height: 95-1/4"
K1111 + K1001 + K1131 = Height: 113"
K1121 + K1001 + K1151 = Height: 95-1/4"
K1121 + K1001 + K1131 = Height: 113"



K1111 + K1101 + K1151 = Height: 96-1/4"
K1111 + K1101 + K1131 = Height: 114"
K1121 + K1101 + K1151 = Height: 96-1/4"
K1121 + K1101 + K1131 = Height: 114"



K1151

Duopolymer®

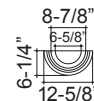

Height: 4-7/8"

K1131

Purotouch®



Height: 22-5/8"

Pilasters

K251

Purotouch®

Height: 13-3/4"

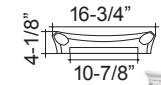

K250

Purotouch®

Height: 78-3/4"

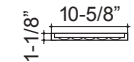

K254 + K250 + K251 = Height: 113-1/2"

K254

Purotouch®

Height: 21-1/8"

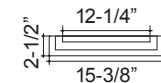

Purotouch® a proprietary polymer blend formulated to create deep reliefs and crisp details.
Duopolymer® high impact resin blend. Ideally suited for baseboards and chair rails.

Water Resistant Paintable Easy-to-Install Superior Quality Flexible

1-800-631-8375 | For Wholesale Pricing: www.oracdecorusa.com

English measurements converted from metric. Metric is the most accurate. All profiles copyrighted and protected by International Law.

Flexible Product

Part #	Min. Inside R	Min. Outside R	Min. Arch R*
CX100F	6' 7" 200cm	6' 7" 200cm	N/A
CX106F	11' 10" 361cm	11' 10" 361cm	N/A
CX109F	5' 3" 160cm	5' 3" 160cm	N/A
CX110F	5' 11" 180cm	5' 11" 180cm	N/A
CX123F	9' 3" 282cm	9' 3" 282cm	N/A
CX124F	5' 3" 160cm	5' 3" 160cm	N/A
CX127F	7' 11" 240cm	7' 11" 240cm	N/A
CX188F	3' 8" 110cm	3' 8" 110cm	N/A
CX189F	3' 90cm	3' 90cm	N/A
CX190F	1' 30cm	1' 30cm	4' 4" 130cm
CX199F	6' 7" 200cm	6' 7" 200cm	N/A
FC211	8' 3" 250cm	8' 3" 250cm	N/A
FC213	9' 3" 280cm	9' 3" 280cm	N/A
FC215	5' 3" 160cm	5' 3" 160cm	N/A
FC216	11' 2" 340cm	11' 2" 340cm	N/A
FC217	12' 6" 380cm	12' 6" 380cm	N/A
FC220	13' 2" 400cm	13' 2" 400cm	N/A
FC230	5' 150cm	5' 150cm	N/A
FC240	8' 11" 270cm	8' 11" 270cm	N/A
FC250	2' 4" 70cm	2' 4" 70cm	N/A
FC321	4' 8" 140cm	4' 8" 140cm	N/A
FC325	9' 11" 300cm	9' 11" 300cm	N/A
FC333	9' 11" 300cm	9' 11" 300cm	N/A
FC334	12' 6" 380cm	12' 6" 380cm	N/A
FC339	12' 6" 380cm	12' 6" 380cm	N/A
FC341	13' 2" 400cm	13' 2" 400cm	N/A
FC373	3' 4" 100cm	3' 4" 100cm	N/A
FC402	9' 11" 300cm	9' 11" 300cm	N/A
FC901	19' 9" 600cm	19' 9" 600cm	N/A
FC902	19' 9" 600cm	19' 9" 600cm	N/A
FP3020	1' 8" 50cm	1' 8" 50cm	5' 11" 180cm
FP4020	1' 4" 40cm	1' 4" 40cm	6' 7" 200cm
FP4025	2' 4" 70cm	2' 4" 70cm	N/A
FP5021	8" 20cm	8" 20cm	2' 4" 70cm
FP7070	1' 30cm	1' 30cm	7' 7" 230cm
FP8020	1' 4" 40cm	1' 4" 40cm	4' 4" 130cm
FP8030	8" 20cm	8" 20cm	2' 4" 70cm
FP8040	1' 30cm	1' 30cm	N/A
FP8050	2' 8" 80cm	2' 8" 80cm	6' 7" 200cm
FP9010	1' 4" 40cm	1' 4" 40cm	10' 3" 310cm
FP9050	8" 20cm	8" 20cm	2' 60cm
FP9900	8" 20cm	8" 20cm	8' 3" 250cm
PX103F	8" 20cm	8" 20cm	2' 8" 80cm
PX120F	1' 30cm	1' 30cm	3' 8" 110cm
PX144F	8" 20cm	8" 20cm	7' 3" 220cm
PX175F	1' 30cm	1' 30cm	2' 8" 80cm
PX198F	2' 4" 70cm	2' 4" 70cm	N/A
PX201F	1' 30cm	1' 30cm	2' 8" 80cm
PX202F	2' 60cm	2' 60cm	5' 150cm
PX209F	8" 20cm	8" 20cm	2' 4" 70cm
SX104F	1' 4" 40cm	1' 4" 40cm	N/A
SX105F	1' 30cm	1' 30cm	N/A
SX118F	1' 4" 40cm	1' 4" 40cm	N/A
SX137F	1' 4" 40cm	1' 4" 40cm	N/A
SX138F	1' 4" 40cm	1' 4" 40cm	N/A
SX155F	1' 30cm	1' 30cm	N/A
SX157F	1' 2" 35cm	1' 2" 35cm	8' 7" 260cm
SX162F	8" 20cm	8" 20cm	2' 8" 80cm

Part #	Min. Inside R	Min. Outside R	Min. Arch R*
SX163F	1' 2" 35cm	1' 2" 35cm	N/A
SX165F	1' 4" 40cm	1' 4" 40cm	N/A
SX172F	1' 2" 35cm	1' 2" 35cm	N/A
SX173F	1' 6" 45cm	1' 6" 45cm	N/A
SX179F	1' 2" 35cm	1' 2" 35cm	N/A
SX180F	1' 6" 45cm	1' 6" 45cm	N/A
SX182F	1' 2" 35cm	1' 2" 35cm	N/A
SX183F	1' 4" 40cm	1' 4" 40cm	N/A
SX184F	1' 6" 45cm	1' 6" 45cm	N/A
SX187F	1' 4" 40cm	1' 4" 40cm	N/A
SX194F	10" 25cm	10" 25cm	2' 8" 80cm
SX195F	1' 30cm	1' 30cm	N/A
SX207F	1' 4" 40cm	1' 4" 40cm	N/A

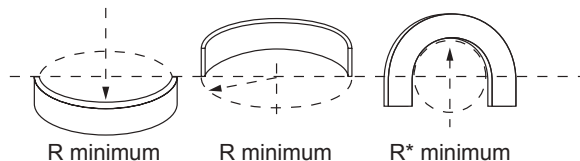

Part #	Min. Inside R**	Min. Outside R**	Min. Arch R*
W108F	1' 4" 40cm	1' 30cm	1' 30cm
W109F	1' 4" 40cm	1' 30cm	1' 30cm
W110F	1' 4" 40cm	1' 30cm	1' 30cm
W111F	1' 4" 40cm	1' 30cm	1' 30cm
W114F	1' 4" 40cm	1' 30cm	1' 30cm
W116F	1' 4" 40cm	1' 30cm	1' 30cm
W119F	1' 4" 40cm	1' 30cm	1' 30cm
W214F	1' 4" 40cm	1' 30cm	1' 30cm
WX205F	1' 4" 40cm	1' 30cm	1' 30cm
WX210F	1' 4" 40cm	1' 30cm	1' 30cm
WX211F	1' 4" 40cm	1' 30cm	1' 30cm

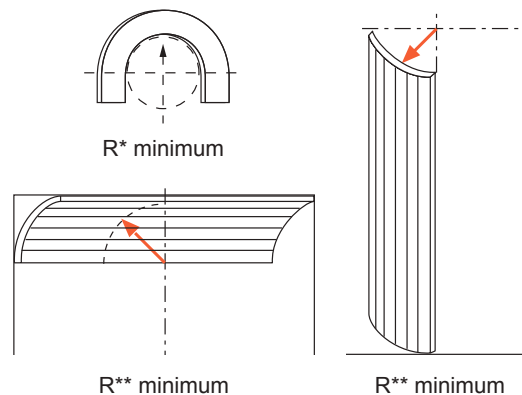

Adhesive

DecoFix Pro



FDP-500
290ml > 7-8m

Extra strong installation adhesive for porous surfaces and interior applications

- Strong, water-based acrylic glue
- Long-lasting seal between mouldings and the wall and/or ceiling
- Remove with humid sponge or cloth
- Should be kept frost free
- Paintable after hardening (min. 24 hours)



Interior



Porous



Dry Surface



Seal Wall & Ceiling



DecoFix Power



FDP-700
290ml > 7-8m

Extra strong MS polymer glue for new build, all exterior applications, non-porous (tiles, glass, ...) surfaces, damp environments and 3D wall covering

- Remove with soap solution
- Paintable after hardening (min. 24 hours)



Exterior



Non-Porous



Humid Surface



Heavy Profiles



DecoFix Ultra



FX400
270ml > 80m

White, polymer-based adhesive for joints between mouldings

- Apply sufficient DecoFix Ultra in every joint.
- Push profiles strongly against each other and remove excess glue with a painter's knife before hardening.
- Use FL300 DecoFiller if needed and finish with sandpaper.
- Can be painted after 24 hrs.



Interior



Porous



Dry Surface



Jointer



DecoFiller



FL300
310ml > 30m

Ready to use lightweight acrylic filler

- For shrink-proof finishing of gaps (between decorative profiles after adhesion, between wall and profiles, between walls and between wall and ceiling), cracks and irregularities in profiles or on walls
- Rapidly repaintable (after 15 min.)
- Does not crack



Interior



Porous



Dry Surface



Seal Wall & Ceiling



Surface & Atmosphere

Storage and installation conditions:
Store profiles and adhesive at room temperature and wait 24 hours before installing.

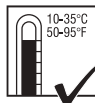

Dust Free



Sand & Wash Surface



Flat Wall & Ceilings



Dry



No Grease

Installation Videos & Manuals

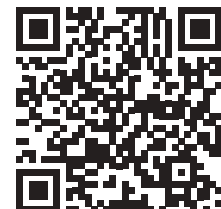

VISIT WWW.ORACDECORUSA.COM
OR SCAN THE QR CODES

Index

C					
C200 ◆■	42	C339 ◆■ FC339 ■	46, 94	C991 ◆■	37, 47, 48, 57
C201 ◆■	45	C340 ◆■	51, 52	C991 + 2x P9900	51
C211 ◆■ FC211 ■	47, 94	C341 ◆■ FC341 ■	46, 57, 94	C991 + P9900	49
C212 ◆■	42	C342 ◆■	49, 58	CB500 ◆■	54
C213 ◆■ FC213 ■	44, 94	C343 ◆■	52, 58	CB501 ◆■	54
C215 ◆■ FC215 ■	41, 94	C344 ◆■	53	CB502 ◆■	55
C216 ◆■ FC216 ■	47, 94	C351 ◆■	38	CB503 ◆■	55
C217 ◆■ FC217 ■	48, 94	C352 ◆■	38	CB510 ◆■	54
C219 ◆■	49	C353 ◆■	47	CB511 ◆■	55
C220 ◆■ FC220 ■	45, 94	C354 ◆■	49	CB512 ◆■	55
C230 ◆■ FC230 ■	40, 94	C355 ◆■	44	CB520 ◆■	54
C240 ◆■ FC240 ■	44, 94	C356 ◆■	43	CB521 ◆■	54
C250 ◆■ FC250 ■	40, 94	C357 ◆■	37	CB522 ◆■	55
C260 ◆■	41	C358 ◆■	37	CB523 ◆■	54
C301 ◆■	49	C360 ◆■	41	CB524 ◆■	55
C303 ◆■	46	C361 ◆■	35	CB525 ◆■	55
C304 ◆■	46	C362 ◆■	35	CB530 ◆■	54
C305 ◆■	47	C371 ◆■	38	CB531 ◆■	54
C305 + C211	49	C373 ◆■ FC373 ■	36, 94	CX100 ◆■ CX100F	43, 94
C305 + C213	48	C374 ◆■	38	CX106 ◆■ CX106F	47, 94
C307 ◆■	51	C380 ◆■	35	CX107 ◆■	47
C307 + C-307A	51	C381 ◆■	36	CX108 ◆■	42
C308 ◆■	50	C382 ◆■	37	CX109 ◆■ CX109F ■	41, 94
C321 ◆■ FC321 ■	44, 94	C383 ◆■	37	CX110 ◆■ CX110F ■	41, 94
C322 ◆■	41	C390 ◆■	36, 43, 57	CX111 ◆■	40
C323 ◆■	36, 42	C391 ◆■	37, 46, 57	CX112 ◆■	42
C324 ◆■	36, 44	C392 ◆■	48, 58	CX115 ◆■	40
C325 ◆■ FC325 ■	43, 94	C393 ◆■	50	CX123 ◆■ CX123F ■	44, 94
C326 ◆■	45	C394 ◆■	36, 43, 57	CX124 ◆■ CX124F ■	42, 94
C327 ◆■	48	C395 ◆■	37, 46, 57	CX126 ◆■	45
C332 ◆■	50	C396 ◆■	38, 48, 58	CX127 ◆■ CX127F ■	45, 94
C333 ◆■ FC333 ■	47, 94	C400 ◆■	45	CX129 ◆■	45
C334 ◆■ FC334 ■	50, 94	C402 ◆■ FC402 ■	46, 94	CX132 ◆■	40, 71
C335 ◆■	52	C422 ◆■	50	CX133 ◆■	40
C336 ◆■	53	C602 ◆■	42	CX134 ◆■	40
C337 ◆■	52	C900 ◆■	38, 49	CX141 ◆■	42
C338 ◆■	50	C901 ◆■ FC901 ■	38, 48, 94	CX148 ◆■	40
C338A	50	C902 ◆■ FC902 ■	37, 46, 94	CX160 ◆■	41
C338B	51	C990 ◆■	51	CX161 ◆■	41
		C990 + 2x P9900	52, 53	CX176 ◆■	43
		C990 + P9900	52	CX177 ◆■	43

◆ 4" moulding samples available

■ 36" architect's samples available

Index

CX188 ◆■ CX188F ■	35, 94	K1112	93	P8030D	65
CX189 ◆■ CX189F ■	35, 94	K1121	93	P8040 ◆■ FP8040 ■	63, 94
CX190 ◆■ CX190F ■	35, 94	K1122	93	P8050 ◆■ FP8050 ■	63, 94
CX192 ◆■	45	K1131	93	P8060 ◆■	61
CX196 ◆■	36, 44, 57	K1132	93	P9010 ◆■ FP9010 ■	63, 90, 94
CX197 ◆■	36, 43, 57	K1151	93	P9020 ◆■	63
CX199 ◆■ CX199F ■	44, 94	K1152	93	P9040 ◆■	61
		K200	91	P9050 ◆■ FP9050 ■	60, 94
D		K201	91	P9900 ◆■ FP9900 ■	62, 94
		K201L/R	107	P9901 ◆■	62
D200	89	K202	91	PB513 ◆■	55
D210	90	K250	93	PX102 ◆■	62
D310	89, 90	K251	93	PX103 ◆■ PX103F ■	60, 65, 94
D330LR	89	K254	93	PX103A	65
D340	89			PX103A + PX103	65
D400	89	P		PX113 ◆■	61
D401	89			PX116 ◆■	60
D402	89	P-101A	65	PX117 ◆■	60
D503	87	P-20	65	PX120 ◆■ PX120F ■	60, 65, 94
D504	87	P-20 + P-101A + P1020	65	PX120A	65
D506	87	P-4020A	65	PX120A + PX120	65
D507	87	P-4020A + P4020	65	PX144 ◆■ PX144F ■	61, 94
DX119 ◆■	89	P-801C	65	PX147 ◆■	87
DX121 ◆■	90	P-801C + P8020	65	PX169 ◆■	87
DX170-2300 ◆■	89	P-8030C	65	PX175 ◆■ PX175F ■	61, 94
DX174-2300 ◆■ DX174F ■	89	P-8030C + P8030	65	PX198 ◆■ PX198F ■	63, 94
		P1020 ◆■	61, 65	PX201 ◆■ PX201F ■	60, 94
F		P3020 ◆■ FP3020 ■	62, 65, 94	PX202 ◆■ PX202F ■	62, 94
		P3020A	65	PX209 ◆■ PX209F ■	60, 94
FDP-500	95	P3020A + P3020	65		
FDP-700	95	P3070 ◆■	64	R	
FL300	95	P3071 ◆■	64		
FX400	95	P4020 ◆■ FP4020 ■	61, 65, 94	R-07	81
		P4025 ◆■ FP4025 ■	63, 94	R-08	81
K		P5021 ◆■ FP5021 ■	60, 94	R-09	82
		P6020 ◆■	62	R-10	81
K1001	93	P7020 ◆■	63	R-11	81
K1002	93	P7030 ◆■	63	R-12	81
K1101	93	P7070 ◆■ FP7070 ■	62, 94	R-13	81
K1102	93	P8020 ◆■ FP8020 ■	62, 65, 94	R-14	81
K1111	93	P8030 ◆■ FP8030 ■	61, 65, 94	R-17	82

◆ 4" moulding samples available

■ 36" architect's samples available

Index

R-18	82	SX185 ◆■	67, 70	W212 ◆■	75
R-22	83	SX186 ◆■	67, 71	W213 ◆■	75
R-23	83	SX187 ◆■ SX187F ■	69, 94	W214 ◆■ W214F ■	75, 94
R-24	83	SX191 ◆■	71	W215 ◆■	75
R-27	83	SX193 ◆■	72	W216 ◆■	76
R-31	81	SX194 ◆■ SX194F ■	68, 94	W217 ◆■	76
R-40	83	SX195 ◆■ SX195F ■	69, 94	W218 ◆■	76
R-46	82	SX206 ◆■	71	WX204 ◆■	76
R-52	82	SX207 ◆■ SX207F ■	72, 94	WX204-2600 ◆■	76
R-64	83	SX212 ◆■	71	WX205 ◆■ WX205F ■	76, 94
R-66	82			WX205-2600 ◆■	76
R-73	83			WX210 ◆■ WX210F ■	77, 94
R-76	82			WX210-2600 ◆■	77
R-77	82			WX211 ◆■ WX211F ■	77, 94
				WX211-2600 ◆■	77
S					
<hr/>					
SX104 ◆■ SX104F ■	71, 94	W			
SX105 ◆■ SX105F ■	70, 94	W100	79		
SX118 ◆■ SX118F ■	67, 70, 94	W101	79		
SX122 ◆■	69	W102	79		
SX125 ◆■	68	W103	79		
SX137 ◆■ SX137F ■	69, 94	W105	79		
SX138 ◆■ SX138F ■	70, 94	W106	79		
SX155 ◆■ SX155F ■	70, 94	W107	79		
SX156 ◆■	71	W108 ◆■ W108F ■	74, 94		
SX157 ◆■ SX157F ■	67, 68, 91, 94	W109 ◆■ W109F ■	74, 94		
SX159 ◆■	68, 91	W110 ◆■ W110F ■	74, 94		
SX162 ◆■ SX162F ■	67, 68, 91, 94	W111 ◆■ W111F ■	74, 94		
SX163 ◆■ SX163F ■	67, 70, 91, 94	W112 ◆■	74		
SX165 ◆■ SX165F ■	67, 68, 94	W113 ◆■	74		
SX168 ◆■	71, 91	W114 ◆■ W114F ■	74, 94		
SX171 ◆■	67, 69	W115 ◆■	74		
SX172 ◆■ SX172F ■	69, 94	W116 ◆■ W116F ■	75, 94		
SX173 ◆■ SX173F ■	67, 69, 94	W117 ◆■	75		
SX179 ◆■ SX179F ■	38, 69, 94	W119 ◆■ W119F ■	75, 94		
SX180 ◆■ SX180F ■	70, 94	W120	85		
SX181 ◆■	71	W120 + P4025 + W121	85		
SX182 ◆■ SX182F ■	67, 68, 94	W120 + 4*W122	85		
SX183 ◆■ SX183F ■	67, 68, 94	W120 + 4*W123	85		
SX184 ◆■ SX184F ■	67, 70, 94	W121	85		
		W121 + W123	85		
		W121 + W122	85		
		W122	85		
		W123	85		
		W130 ◆■	75		

◆ 4" moulding samples available

■ 36" architect's samples available



Visit our new
and improved website.

ORAC

BY OUTWATER

www.oracdecorusa.com

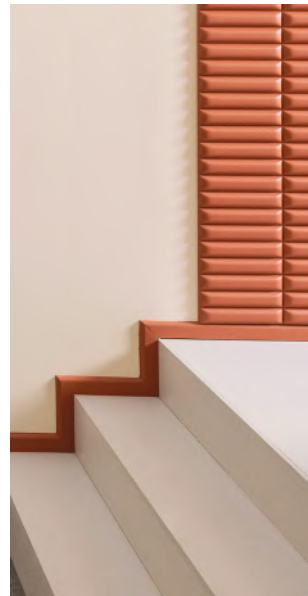

ORAC

BY OUTWATER

New Jersey
24 River Road
Bogota, NJ 07603

Pennsylvania
390 N. Pennsylvania, Ave.
Wilkes Barre, PA 18702

Arizona
4720 West Van Buren St.
Phoenix, AZ 85043

Belgium
Biekorfstraat 32,
8400 Ostend, Belgium



1-800-631-8375
www.oracdecorusa.com

CATALOG 2402